

Thank you very much for choosing this vehicle.

In order to correctly operate and maintain your vehicle, please take the time to read this manual carefully.

After reading, please leave the manual in the vehicle for future reference. Please leave this manual in the vehicle at the same time of resale, as the new owner will also need to read the information in it.

All the information and specifications in this manual are current at the time of printing.

Remember that authorized service centres know your vehicle best and have factory-trained technicians and OEM parts to guarantee your safety. Do not use non-OEM parts or accessories to modify your vehicle. Modifying will affect the functionality, safety and durability of your vehicle.

According to the specification of equipment and features of your vehicle, some descriptions and illustrations may differ from that on your vehicle.

Any data, descriptions and illustrations provided in this manual cannot be used as the basis for any insurance claim.

We reserves the right to make changes in design and specifications at any time without notice.

All rights reserved. This document should not be reproduced or copied, in whole or in part, without the written permission.

Happy driving!

Version No: T19COM24EN01
Issued June 2024

Pictorial Index

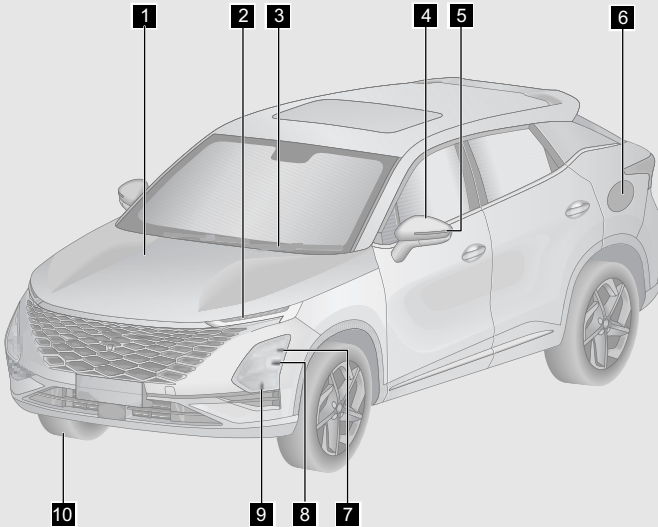

1	Bonnet	P.113
2	Position light.....	P.39
	Front indicator light.....	P.40
	Daytime running light.....	P.41
3	Front wiper blade	P.37
4	Outside rear view mirror	P.34
5	Side indicator light.....	P.40
6	Fuel tank cover	P.118
7	High beam light.....	P.39
8	Low beam light	P.39
9	Front fog light	P.41
10	Tyre	P.215

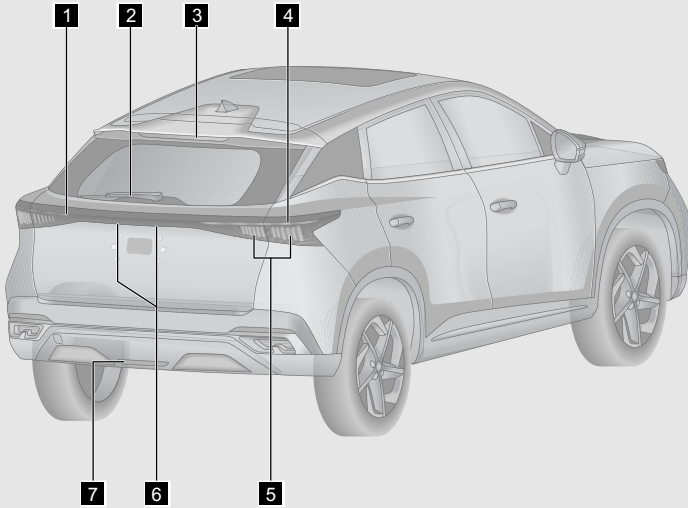

1 Reverse light	P.42
2 Rear wiper blade	P.37
3 High mounted brake light	P.42
4 Rear indicator light	P.40
5 Brake light.....	P.42
Rear position light	P.39
6 License plate light	P.42
7 Rear fog light.....	P.41

Note: Please refer to the actual vehicle.

Pictorial Index

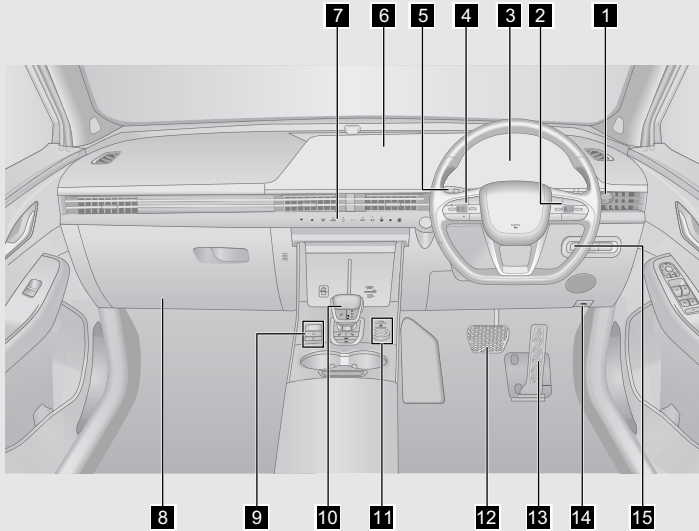

1 Headlight stalk switch	P.39
2 Audio button	P.91
3 Instrument cluster	P.22
4 Cruise button	P.150
5 Wiper stalk switch	P.35
6 Audio head unit	P.87
7 A/C control panel	P.96
8 Glove box	P.108
9 Electric parking brake button	P.131
Auto hold button	P.133
10 Shift lever	P.127
11 Audio system control button	P.87
Panoramic view monitor switch	P.177
12 Brake pedal	
13 Accelerator pedal	
14 Bonnet release lever	P.113
15 Power boot door opening switch (if equipped)	P.115

Note: The interiors are different depending to the market requirement. Please refer to the actual vehicle.

Table of Contents

1. INTRODUCTION

- 1-1. How to Read This Manual
 - How to Read This Manual.....2
 - Table of Contents2
 - Pictorial Index2
 - Index2
- 1-2. "Face to face" Consultative Service Card
 - "Face to face"
Consultative Service
Card3
- 1-3. Symbols in the Manual
 - Symbols in the Manual7
- 1-4. New Vehicle Inspection
 - New Vehicle Inspection8
 - Delivery Inspection
Certificate.....8
- 1-5. New Vehicle Break-in
 - New Vehicle Break-in9
- 1-6. How to Save Fuel and Extend Life of Vehicle
 - How to Save Fuel and
Extend Life of Vehicle..... 10
- 1-7. Precautions Before Driving Vehicle
 - Safety Check 11
 - Before Starting Engine 11
 - After Starting Engine..... 12
 - When Driving 12
 - Parking Operations..... 12
 - Parking on Slope 13
 - Check the Exhaust
System 14
- 1-8. Off-road Driving Precautions
 - Off-road Driving..... 15

- 1-9. Precautions When Driving in the Rain
 - When Driving on
Slippery Road Surfaces..... 16
 - Never Drive Through
Flooded Water 16
- 1-10. Winter Driving Precautions
 - Winter Driving Tips 17
 - Driving on Road
Covered with Ice and
Snow 18
 - Tyre Chains 18
- 1-11. Cybersecurity Notice
 - Cybersecurity Support
Service Update or
Termination Notice..... 20
 - Cybersecurity Notice for
Scrapping or Resale 20

2. PREPARATION FOR DRIVING

- 2-1. Instrument Cluster
 - Instrument Cluster View 22
 - Operating the meter
control buttons 24
 - Information Display Area ... 24
- 2-2. Operation/Malfunction Indicator
 - Operation/Malfunction
Indicator..... 27
- 2-3. Steering Wheel
 - Horn 32
 - Heated Steering Wheel
(If Equipped)..... 32
 - Adjusting Steering
Wheel..... 33

Table of Contents

2-4. Rear View Mirror	Child Presence Detection in Rear Seat (If Equipped)..... 65
Automatic Inside Rear View Mirror 34	
Outside Rear View Mirror..... 34	
2-5. Wiper System	3. INTERIOR FUNCTION
Wiper Operation..... 35	3-1. Key Information
Wiper Blade Replacement 37	Key Information..... 69
2-6. Lighting System	Replacing Key Battery..... 70
Exterior Lighting 39	Effective Range..... 72
Interior Lighting 42	Keyless Entry..... 73
Follow Me Home Function..... 43	Vehicle Security 74
Smart Vehicle Locating Function..... 43	Immobilizer System 75
Intelligent Headlight Function (IHC) 44	Remote Start 76
Fogging Instructions for Light..... 44	3-2. Doors
2-7. Seats	Doors Lock Switch..... 77
Head Restraints 45	Unlocking Doors with Inside Handle 77
Front Seats 46	Door Mechanical Switch 78
Second Row Seat..... 48	Rear Door Child Lock..... 79
Seat Heating Function (If Equipped)..... 49	3-3. Windows
2-8. Seat Belts	Power Windows 80
Seat Belts 49	Window Remote Control Function..... 81
Seat Belt Pretensioner 54	Window Jam Protection Function..... 82
2-9. Child Restraint Systems	3-4. Power Moon Roof
Safety Instructions for Using Child Restraint System 55	Power Moon Roof (If Equipped) 84
Recommended Child Restraint Systems 57	Moon Roof Remote Control Function (If Equipped) 85
Top Tether 58	Moon Roof Jam Protection Function (If Equipped) 86
Installing Child Restraint Systems..... 60	3-5. Audio System
Enabling and Disabling Front Passenger Airbag..... 64	Audio View 87
	Audio Operation 88
	Audio Settings 88
	Audio Button..... 91
	Voice Recognition Function..... 91

Table of Contents

Phone-link.....	92	3-13.Boot Door	
3-6. Air Conditioning System		Manual Boot Door	114
Electric Air Conditioning	96	Power Boot Door.....	115
Automatic Air Conditioning	97	Boot Door Emergency Opening.....	118
Mode Adjustment	101	3-14.Fuel Tank Cover	
Air Outlets Airflow Control.....	101	Fuel Tank Cover.....	118
Interior Active Ventilation and Automatic Cleaning (If Equipped)	102	4. DRIVING VEHICLE	
Air Quality Control System (If Equipped)	103	4-1. Vehicle Power Mode	
Air Conditioning Cooling Operation.....	103	ENGINE START STOP Switch	122
Air Conditioning Heating Operation.....	105	4-2. Starting and Turning off Engine	
Auxiliary Fascia Armrest Box Cooling / Warming Function (If Equipped).....	105	Normal Starting and Turning off.....	123
3-7. Wireless Charging		Starting and Turning off in Emergency.....	124
Wireless Charging	105	Petrol Particulate Filter (PPF) (If Equipped).....	125
3-8. Assist Grips and Coat hooks		Adaptive Engine Control System	126
Assist Grips	107	4-3. Transmission	
Coat hooks.....	107	Automatic Transmission	126
3-9. Storage Space		4-4. Steering System	
Storage Space.....	108	Electric Power Steering System (EPS)	129
3-10.Power Outlet		4-5. Brake System	
Power Outlet.....	110	Electric Parking Brake System (EPB).....	131
USB Port.....	111	Automatic Parking System (AUTO HOLD)....	133
3-11.Sun Visors and Vanity Mirrors		Vacuum Booster.....	135
Sun Visors, Vanity Mirrors and TicketClips....	112	Brake.....	136
3-12.Bonnet		4-6. SRS Airbags	
Opening/closing the bonnet.....	113	SRS Airbags.....	137

Table of Contents

5. DRIVING ASSIST

5-1. Speed Limit Assist System (SLA)

Speed Limit Assist System (SLA) (If Equipped) 149

5-2. Cruise System

Adaptive Cruise Control System (ACC) 150
Active Speed Limit..... 155

5-3. Hill Descent Control System (HDC)

Hill Descent Control System (HDC) (If Equipped) 157

5-4. Lane Departure Warning System (LDW)

Lane Departure Warning System (LDW)..... 158

5-5. Lane Departure Prevention System (LDP)

Lane Departure Prevention System (LDP)..... 160

5-6. Emergency Lane Keeping (ELK) System

Emergency Lane Keeping (ELK) System 162

5-7. Blind Spot Detection (BSD) System

Blind Spot Detection (BSD) System 163
Rear Cross Traffic Alert (RCTA) System 164
Rear Cross Traffic Braking (RCTB) System (If Equipped)..... 164

5-8. Automatic Emergency Braking System (AEB) / Front Collision Warning System (FCW)

Automatic Emergency Braking System (AEB) / Front Collision Warning System (FCW) 166

5-9. Traffic Jam Assist System (TJA) / Integrated Cruise Assist System (ICA)

Traffic Jam Assist System (TJA) / Integrated Cruise Assist System (ICA) 169
Intelligent Avoidance System 171

5-10. Drive Away Information System

Drive Away Information System 172

5-11. Tyre Pressure Monitoring System (TPMS)

Tyre Pressure Monitoring System (TPMS) 172

5-12. Driver Monitor System (DMS)

Driver Monitor System (DMS)..... 175

5-13. Parking Assist System

Parking View Monitor System (If Equipped) 176
Panoramic View Monitor System (If Equipped) 177
Parking Radar System 181

Table of Contents

5-14. Multi-Collision Brake System (MCB) Multi-Collision Brake System (MCB)	183	Emergency Towing	202
5-15. Braking Force Control System Electronic Stability Program System (ESP) ... Anti-lock Brake System (ABS)	184 185	6-4. Fuse Fuse Box	203
Extended Function	187	Checking Fuse	204
5-16. Data Privacy Driver Drowsiness and Attention Warning (DDAW)	187	Replacing Fuse	205
Advanced Driver Assistance System (ADAS)	188	7. MAINTENANCE	
Emergency call (eCall)	188	7-1. Repair and Maintenance Repair and Maintenance	208
6. IN CASE OF AN EMERGENCY		Authorized Service Centre is at Your Service	208
6-1. Basic Knowledge of Vehicle Emergency Hazard Light	190	Safety Check	209
Reflective Strip	191	7-2. Normal Maintenance Normal Maintenance	210
Warning Triangle	191	Checking Oil Level	211
Spare Tools (If equipped)	191	Checking Transmission Fluid Level	212
6-2. Vehicle Emergency Handling If You Have a Flat Tyre While Driving	192	Checking Brake Fluid Level	212
If Engine Coolant Temperature is High	197	Checking Coolant Level	213
If Battery is Flat	198	Checking Radiator and Condenser	214
If Your Vehicle Cannot Start Normally	200	Checking Drive Belt	214
6-3. Towing Towing Vehicle	200	Checking Tyres	215
Installing Towing Eyelet ...	202	Tyre Rotation	217
		Checking Battery	217
		Checking Air Conditioning Filter	217
		Checking Windshield Washer Fluid	218
		Checking Wiper Blades ...	218
		8. SPECIFICATION	
		8-1. Label Location Vehicle Identification Number (VIN)	222
		Vehicle Product Label	223
		Engine Number	223

Table of Contents

RF Emitter and Reciever Installation (If Equipped)	223	Wheel Alignment	228
8-2. Vehicle Specifications		Wheels and Tyres.....	228
Vehicle Dimensions	224	Battery	229
Vehicle Type	225	Light Bulb Specification ...	229
Vehicle Weight.....	225	Vehicle Components That Are Not Included in the Vehicle Size	230
Vehicle Performance.....	226	Your Rights.....	231
Engine Performance	226	Contact Us	231
Fuel System	227		
Suspension System.....	227		

ALPHABETICAL INDEX

1-1. How to Read This Manual	When Driving..... 12
How to Read This Manual2	Parking Operations..... 12
Table of Contents2	Parking on Slope..... 13
Pictorial Index.....2	Check the Exhaust System 14
Index.....2	
1-2. "Face to face" Consultative Service Card	1-8. Off-road Driving Precautions
"Face to face" Consultative Service Card3	Off-road Driving 15
1-3. Symbols in the Manual	1-9. Precautions When Driving in the Rain
Symbols in the Manual7	When Driving on Slippery Road Surfaces..... 16
1-4. New Vehicle Inspection	Never Drive Through Flooded Water 16
New Vehicle Inspection8	1-10. Winter Driving Precautions
Delivery Inspection Certificate8	Winter Driving Tips 17
1-5. New Vehicle Break-in	Driving on Road Covered with Ice and Snow 18
New Vehicle Break-in.....9	Tyre Chains..... 18
1-6. How to Save Fuel and Extend Life of Vehicle	1-11. Cybersecurity Notice
How to Save Fuel and Extend Life of Vehicle 10	Cybersecurity Support Service Update or Termination Notice 20
1-7. Precautions Before Driving Vehicle	Cybersecurity Notice for Scrapping or Resale 20
Safety Check..... 11	
Before Starting Engine 11	
After Starting Engine..... 12	

1. INTRODUCTION

1-1. How to Read This Manual

How to Read This Manual

There are three ways for you to find the information you need in this manual. Here is a brief introduction of each one.

Table of Contents

The main Table of Contents will tell you which chapter of the Owner's Manual contains the information you need and what page to find it on.

Pictorial Index

The Pictorial Index is a helpful tool to find the required information quickly, especially if you are not familiar with the component name.

Index

This is the fastest method for you to find the information you need. The index contains a complete listing of all the important vehicle terminologies.

1-2. "Face to face" Consultative Service Card

"Face to face" Consultative Service Card

Authorized service centre will provide a dedicated service consultant when you purchase your vehicle. If you have any questions concerning your vehicle, please consult the consultant.

Sheet One (for User)

Name of User:	Date of Purchase:
Sales & Servicing Department:	Model:
Vehicle Identification Number (VIN):	
The following items should be confirmed by the user:	
1. Vehicle Delivery and Inspection (Mark a " √ " for " Yes " and a " × " for Other Conditions):	
<input type="checkbox"/>	Have introduced the basic operation of the vehicle to the user and performed the delivery inspection.
<input type="checkbox"/>	Have explained the warranty policies to the user.
<input type="checkbox"/>	Have explained the precautions of driving to the user.
<input type="checkbox"/>	Have explained the importance of regular maintenance and the recommended interval time/mileage for regular maintenance to the user.
<input type="checkbox"/>	Have explained to the user the importance of having regular maintenance or vehicle repairs done at authorized service centre.
<input type="checkbox"/>	Have delivered the Owner's Manual to the users and reminded them to read it.
<input type="checkbox"/>	Have informed the user about the service hotline function and how to use it.
2. "Face to face" Consultative Service Mode Introduction (Mark a " √ " for " Yes " and a " × " for Other Conditions):	
<input type="checkbox"/>	If you have any questions or concerns, ask your service consultant.
<input type="checkbox"/>	The service consultant is the only person authorized by the service centre to answer the user's questions.
<input type="checkbox"/>	Have assigned a dedicated service consultant to each user for "Person to- Person" service.
<input type="checkbox"/>	If the user is not fully satisfied with the service consultant, the user can request another service consultant.
The following items should be confirmed by the user:	

1. INTRODUCTION

3. Main Work Introduction on Service Consultant (Mark a " ✓ " for " Yes " and a " × " for Other Conditions):

<input type="checkbox"/>	Service reception during service and maintenance.
<input type="checkbox"/>	Regular maintenance reminders.
<input type="checkbox"/>	Answer the service/maintenance consultation.
<input type="checkbox"/>	Service/maintenance booking.
<input type="checkbox"/>	Annual inspection reminders.
<input type="checkbox"/>	Regular check up and service reminders and holiday greetings.
<input type="checkbox"/>	Other concerns from the user.

4. "Face to face" Consultative Service Relationship Establishment:

Service consultant business card

Signature of User/Date:

Signature of Service Consultant/Date:

Sheet Two (for Sales & Servicing Department)

Name of User:	Date of Purchase:
Sales & Servicing Department:	Model:
Vehicle Identification Number (VIN):	
The following items should be confirmed by the user:	
1. Vehicle Delivery and Inspection (Mark a " √ " for " Yes " and a " × " for Other Conditions):	
<input type="checkbox"/>	Have introduced the basic operation of the vehicle to the user and performed the delivery inspection.
<input type="checkbox"/>	Have explained the warranty policies to the user.
<input type="checkbox"/>	Have explained the precautions of driving to the user.
<input type="checkbox"/>	Have explained the importance of regular maintenance and the recommended interval time/mileage for regular maintenance to the user.
<input type="checkbox"/>	Have explained to the user the importance of having regular maintenance or vehicle repairs done at authorized service centre.
<input type="checkbox"/>	Have delivered the Owner's Manual to the users and reminded them to read it.
<input type="checkbox"/>	Have informed the user about the service hotline function and how to use it.
2. "Face to face" Consultative Service Mode Introduction (Mark a " √ " for " Yes " and a " × " for Other Conditions):	
<input type="checkbox"/>	If you have any questions or concerns, ask your service consultant.
<input type="checkbox"/>	The service consultant is the only person authorized by the service centre to answer the user's questions.
<input type="checkbox"/>	Have assigned a dedicated service consultant to each user for "face to face" service.
<input type="checkbox"/>	If the user is not fully satisfied with the service consultant, the user can request another service consultant.
The following items should be confirmed by the user:	
3. Main Work Introduction on Service Consultant (Mark a " √ " for " Yes " and a " × " for Other Conditions):	
<input type="checkbox"/>	Service reception during service and maintenance.
<input type="checkbox"/>	Regular maintenance reminders.
<input type="checkbox"/>	Answer the service/maintenance consultation.
<input type="checkbox"/>	Service/maintenance booking.

1. INTRODUCTION

<input type="checkbox"/>	Annual inspection reminders.
<input type="checkbox"/>	Regular check up and service reminders and holiday greetings.
<input type="checkbox"/>	Other concerns from the user.
4. "Face to face" Consultative Service Relationship Establishment:	
Service consultant business card	
Signature of User/Date:	
Signature of Service Consultant/Date:	

1-3. Symbols in the Manual

Symbols in the Manual

The following symbols are used in this manual to draw your attention to particularly important information. In order to minimize the risks as much as possible, please read the instructions on these symbols carefully before driving, and make sure to follow them.

 **WARNING**

Indicates a potentially hazardous situation which, if not avoided, may result in damage to your vehicle, personal injury or even death.

 **CAUTION**

Indicates a potentially hazardous situation which, if not avoided, may result in damage to your vehicle and its equipment, reducing the vehicle's life span.

 **ENVIRONMENTAL PROTECTION**

Indicates that the waste must be handled or disposed according to the local environmental protection regulations, otherwise, the environment will be contaminated.

 **READ**

Indicates that the relevant chapter in this manual must be read before any operation.

WARNING and CAUTION relating to personal safety and vehicle safety in this manual are very important. Make sure everyone in the vehicle follows these instructions carefully in order to both enjoy your driving experience and to keep your vehicle in optimum condition.

1. INTRODUCTION

1-4. New Vehicle Inspection

New Vehicle Inspection

Before delivering the vehicle to you, the Sales & Servicing department of your service centre has inspected it according to regulations. The Sales & Servicing department of the vehicle should fill the delivery date in the inspection certificate and affix the official seal of service centre.

The service centre will familiarize you with your vehicle and verify it via the "- Delivery Card" which will be signed by both parties.

Delivery Inspection Certificate

In witness whereof, this vehicle has passed delivery inspection as regulated. and quality meets technical specification.

Vehicle Model	
Vehicle Identification Number (VIN)	
Engine Number or Transmission Number	
Vehicle Registration Number	
Official Seal of Sales & Servicing Department:	
Signature of Servicer:	
Delivery Date	
User	
Address	
E-mail	
Telephone	
Have provided and explained the following items for me: <ul style="list-style-type: none">• VEHICLE• OWNER'S MANUAL• PRE-DELIVERY INSPECTION	
Signature of User:	
Signature of Servicer:	

1-5. New Vehicle Break-in

New Vehicle Break-in

Frictional resistance between the moving parts of a new vehicle is much more likely in the initial use of the vehicle than later on. Therefore, the initial use can have a greater impact on the vehicle's lifespan, operational reliability and economy. We advise that the use of a new vehicle must strictly follow the following guidelines and that the break-in period would be on average the first 1,864 miles (3,000 km) driven.

■ Driving regulations of new vehicle break-in period

Within the first 621 miles (1,000 km):

- Avoid driving at full speed.
- Driving speed should not exceed 62 mph (100 km/h).
- Avoid driving at maximum speed in each gear.

Within the first 621 miles (1,000 km) to 932 miles (1,500 km):

- Driving speed can be gradually increased to the highest speed;
- Engine speed can be gradually increased to the maximum allowable speed.

■ Driving recommendations after break-in period

- When driving a vehicle, the maximum speed which engine allows to run in short time is 6,000 r/min. When shifting manually, shift to nearby high gear while the tachometer pointer reaches the red indicator zone.
- Engine speed should not be too low while driving, so it will be necessary to shift to the appropriate gear. Do not run the engine at maximum speed in neutral or other gears if the engine is cold.

■ Tyre and wheel break-in recommendations:

When starting to use new tyres, the best adhesion is not available. Therefore, new tyres also need break-in, so the vehicle should be driven slowly and especially carefully within the first 62 miles (100 km) of driving.

■ Braking system break-in recommendations:

New brake lining also needs break-in. Because the brakes cannot provide the ideal brake friction during the first 124 miles (200 km). If the braking efficiency is slightly worse at this stage, increase depression force on the pedal appropriately. This condition also applies to the each replacement of braking lining later.



ENVIRONMENTAL PROTECTION

Avoid running engine at unnecessary high speed. Switching to a high gear in time is helpful to save fuel, reduce operation noise and reduce environmental pollution.

1. INTRODUCTION

1-6. How to Save Fuel and Extend Life of Vehicle

How to Save Fuel and Extend Life of Vehicle

Saving fuel is largely determined by vehicle conditions and driving habit. Do not overuse the vehicle, which also helps to extend vehicle's life.

The followings conditions are specific tips for fuel saving:

1. Make sure to maintain proper tyre inflation pressure. Insufficient tyre inflation pressure will lead to tyre wear and fuel wastage.
2. The vehicle should not be loaded with unnecessary weight. Heavy loads increase the engine load, resulting in high fuel consumption.
3. Avoid warm-up idling for prolonged periods of time. The vehicle can be driven once the engine runs smoothly. The warm-up time in cold weather will be longer than other seasons.
4. Accelerate slowly and smoothly. Avoid sudden accelerating.
5. Avoid engine idling for prolonged periods of time. If you need to park vehicle and wait for prolonged periods of time, you should turn off the engine and turn it on again later.
6. Avoid out-of-gear or overspeed of engine. Select proper gears according to driving road conditions.
7. Avoid continuous acceleration and deceleration. Stop-and-go driving will waste the fuel.
8. Avoid unnecessary stopping and braking. You should keep a stable speed. Avoid excessive braking and frequent stops/starts to minimise fuel waste. Maintain a proper driving distance with other vehicles to avoid sudden braking, this will also reduce brake wear.
9. Avoid areas with heavy traffic or traffic jams as much as possible.
10. Do not hold your foot on clutch or brake pedals for prolonged periods of time. This will cause premature wear, overheating and high fuel consumption.
11. Keep a proper vehicle speed on the motorway. The faster the vehicle speed, the more fuel consumption. Decreasing vehicle speed will save fuel.
12. Keep proper front wheel alignment. Avoid collision with road curbs and reduce your vehicle speed when driving on rough road surfaces. Improper front wheel alignment will not only quicken tyre wear, but also increase engine load.
13. Avoid contacting vehicle chassis with mud, etc.
14. Maintain vehicle in optimal working condition. Dirty air filter, improper valve clearance, dirty spark plugs, dirty oil and grease, brakes without proper adjustment, etc. can reduce engine performance and waste fuel. Regular maintenance will extend your vehicle's life and reduce your driving costs.

Your vehicle needs to be serviced more frequently if you regularly drive in severe conditions.

 CAUTION

Never turn off engine when driving downhill. The power steering system and brake system will not operate normally when engine is not running.

1-7. Precautions Before Driving Vehicle

Safety Check

It is better to do a safety check before driving vehicle. A few minutes of checking can help ensure safe and pleasant driving.

 WARNING

If you perform this check in an enclosed garage, make sure there is adequate ventilation.

Before Starting Engine

■ Outside vehicle

1. Tyres (including spare tyre): Check tyre pressure with a tyre pressure gauge and carefully check tyres for cuts, damage or excessive wear.
2. Wheel bolts: Make sure no wheel bolts are missing or loose.
3. Fluid leaks: After the vehicle has been parked for a while, check underneath for leaking fuel, oil, coolant or other fluids (Water dripping from air conditioning after use is normal).
4. Lights: Make sure the headlights, daytime running lights, brake lights, fog lights, indicator lights and other lights are working properly.
5. Intake grilles: Remove snow, leaves or other obstructions from the intake grilles in front of windshield.

■ Inside vehicle

1. Spare tools: Make sure you have spare tools, such as jack, wheel bolt wrench and spare tyre.
2. Seat belts: Check if the buckles can be fastened securely. Make sure belts are not worn or frayed.
3. Instrument cluster and controls: Make especially sure the malfunction indicator lights, indicator lights, and controls are working properly.
4. Brakes: Make sure the pedal has enough clearance.

1. INTRODUCTION

■ Engine compartment and engine

1. Spare fuses: Make sure spare fuses are available. All the fuses with amperage ratings designated on the fuse box cover should be provided.
2. Coolant level: Make sure coolant level is correct.
3. Battery and cables: Check for corroded or loose terminals and a cracked case. Check the cables for good condition and connections.
4. Wiring: Check for damaged, loose or broken wires.
5. Fuel lines: Check the lines for leaks or loose connections.

■ Bonnet

Make sure the bonnet is locked completely before driving. Otherwise, the bonnet may tilt up and block front view when vehicle is moving, which could lead to an accident.

After Starting Engine

1. Exhaust system: Listen for any leakage. Repair any leaks immediately if such condition occurs.
2. Engine oil level: Stop vehicle on level ground, turn off engine and wait for 5 minutes, pull out the dipstick to check if the engine oil level is proper.

When Driving

1. Gauges and meters: Make sure the gauges and meters are working properly.
2. Brakes: At a safe place, check that the vehicle does not pull to one side when the brakes are applied.
3. Other abnormal conditions: Check for loose parts and leaks. Listen for abnormal noises.

Parking Operations

Proper parking is an important part of safe driving. Vehicle should be parked in a place with wide road, good view and no impact on traffic. Parking operation steps are as follows:

1. Depress brake pedal until the vehicle is completely stopped.
2. Confirm that the electronic parking is enabled.
3. Move shift lever to "P" position.
4. Turn ENGINE START STOP switch to OFF mode.

 CAUTION
When you leave vehicle, make sure to lock your vehicle and carry the keys with you.

Parking on Slope

Parking vehicle on a slope is mainly enabled by the force of the parking brake. Failing to apply park brake or any brake malfunction may cause the vehicle to slide down a slope and personal injury or damage to vehicle. When parking on a slope, it is better to face the tyres towards one side of vehicle, to prevent vehicle from moving accidentally.

■ Parking on downhill with curb

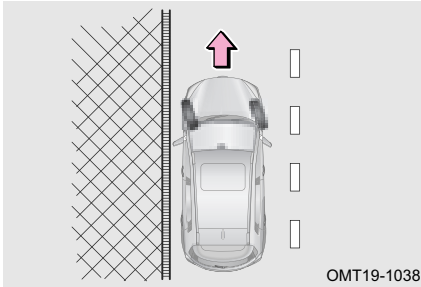

If there is a curb on the roadside, turn the steering wheel to the left to ensure that the front part of the front left wheel is close to or against the curb, to prevent the vehicle from sliding forward down the slope, then apply the parking brake.

■ Parking on uphill with curb

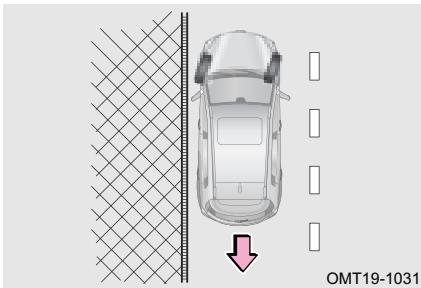

If there is a curb on the roadside, turn the steering wheel to the right to ensure that the rear part of the front left wheel is close to or against the curb, to prevent the vehicle from sliding back down the slope, then apply the parking brake.

■ Parking on uphill or downhill (without curb)

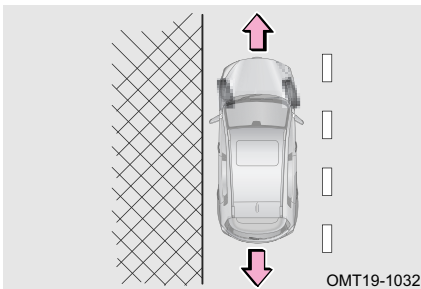

If there is no curb on the roadside, turn the steering wheel hard left to prevent the vehicle driving into the center of the road or sliding down the slope. Turn the steering wheel to the side of the road, so the vehicle is facing away from the center of the road when moving, then apply the parking brake.

1. INTRODUCTION

■ Carrying passengers

Before driving, make sure all passengers sit in their seats with their seat belts properly fastened. Do not let the passengers sit in the places where there are no seats and seat belts, as they are likely to face serious injury during a collision.

■ Locking the vehicle

- When leaving the vehicle unattended, carry smart key with you and lock all the doors, even if parking the vehicle in the garage or on the road outside your house.
- Vehicle should be parked in bright and spacious places as much as possible, and do not expose valuable items.

■ Exhaust gas

- Avoid inhaling the engine exhaust gas. It contains carbon monoxide (CO), which is a harmful, colorless and odorless gas. It can cause unconsciousness or even death after inhaling.
- Make sure the exhaust system has no leakage holes or loose connections. The exhaust system should be checked regularly. If a change in exhaust gas sound is heard, please have the system checked immediately.
- Do not run the engine in a garage or an enclosed area, unless moving the vehicle in or out. The exhaust gas cannot escape, which may cause serious injury.
- Do not stay in a parked vehicle for prolonged periods of time with the engine running. If it is unavoidable, vehicle should be parked in a spacious area and adjust heating and cooling system to forcibly introduce outside air into vehicle.
- Keep the boot door closed while driving. An open or unclosed boot door may cause exhaust gas to enter the vehicle.
- To achieve proper operation of vehicle ventilation system, keep intake grilles free of snow, leaves, or other obstructions.
- If you smell exhaust fumes in vehicle, open windows to allow fresh air to enter and check vehicle condition.

Check the Exhaust System

The exhaust system should be checked in the following situations:

1. When you smell exhaust fumes;
2. When you notice a changed noise coming from the exhaust system;
3. When exhaust system is damaged due to vehicle collision;
4. When the vehicle is lifted for inspection and repair.

1-8. Off-road Driving Precautions

Off-road Driving

Always observe the following precautions to minimize the risk of serious personal injury or damage to your vehicle:

- Be careful when driving off road. Do not drive in dangerous areas.
- Place both hands on the outer ring of the steering wheel when driving off roads.
- Always check your brakes for effectiveness immediately after driving on roads covered with sand, mud, shallow water or snow.
- The driver and all passengers should fasten their seat belts whenever vehicle is moving.

WARNING

- After driving on road surfaces covered with tall grass, mud, gravel, sand, rivers, etc., check if there is grass, bush, paper, rags, stone, sand, etc. adhering to or trapped on underbody. Clear off any above materials from the underbody. If driving vehicle with those matters trapped on or adhering to the underbody, a breakdown or fire could occur.
- When driving off road or on rugged terrain, high speed driving, jumping, sharp turning and striking objects, etc. are forbidden. Failure to do so may cause loss of control or vehicle rollover, resulting in death or severe personal injury. You are also risking expensive damage to your vehicle's suspension and chassis.

1. INTRODUCTION

1-9. Precautions When Driving in the Rain

When Driving on Slippery Road Surfaces

Drive carefully when it is raining, because visibility will be reduced, windows may become fogged-up and roads will be slippery.

- Do not drive at high speed when driving on a motorway in rain, because there may be a layer of water between tyres and road surface, preventing steering system and brakes from operating properly.

CAUTION

- Sudden braking, acceleration and steering on slippery road surfaces may cause tyre slippage and reduce your ability to control vehicle, resulting in an accident.
- Sudden changes in engine speed, such as sudden braking may cause vehicle to skid, resulting in an accident.
- After driving through a puddle, lightly depress brake pedal to make sure brakes are functioning properly. Wet brake lining may prevent brakes from functioning properly. If brake lining on one side is wet and not functioning properly, steering control may be affected, resulting in an accident.

Never Drive Through Flooded Water

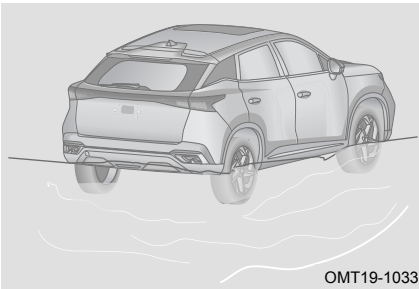

OMT19-1033

The vehicle could be seriously damaged when driving on a road that has flooded.

 CAUTION

- Never drive through water that is deeper than wheel rim.
- Water intrusion into engine can cause it to stall, or cause serious internal damage.
- Water can wash the grease from the wheel bearing, causing rusting and premature abrasion.
- Driving through water may cause damage to your vehicle drive train components. Always visually inspect your vehicle's fluids (e.g. engine oil, transmission fluid, etc.) for signs of leakage after driving through water. Do not continue to operate vehicle if any fluid leaks, as this may result in further damage.
- Vehicle traction and braking performance will decrease while driving through water. The braking distance will increase. Sand and mud that have accumulated around the brake discs may affect the braking efficiency and may damage the brake system components. After driving through water, slightly depress the brake pedal several times to dry the brakes off.

1-10. Winter Driving Precautions

Winter Driving Tips

- **Coolant:** Make sure that coolant has anti-freezing function. Only use coolant recommended.
- **Battery and cables:** Low temperature will decrease power of battery. Sufficient power should be stored in battery for starting in winter.
- **Oil:** In winter, it is recommended to choose appropriate engine oil according to the local temperature condition. The lower viscosity at low temperature, the better fluidity at low temperature, indicating that the lower the ambient temperature at which the oil can be used.
- **Door locks:** Avoid door locks being frozen. Deicing agent or glycerin should be sprayed into door lock holes.
- **Washer fluid:** Use washer fluid containing antifreeze. This product is available at authorized service centre and most vehicle component distributors.
- **Mudguards:** Avoid ice and snow accumulation under mudguards. Failure to do so may cause difficult steering. When driving in cold weather, you should often stop vehicle to check for ice and snow accumulation under mudguards. It is recommended that you should take some necessary emergency items with you according to different driving destinations. Items that need to be put in vehicle: Tyre chains, window snow scraper, sand or salt bag, signal flasher, shovel, jumper cables, etc.

1. INTRODUCTION

CAUTION

- Do not use water as a substitute for coolant.
- Do not use engine coolant or other alternative washer fluid, otherwise vehicle paint will be damaged.

Driving on Road Covered with Ice and Snow

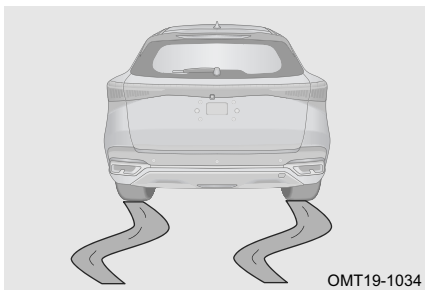

Rapid acceleration on slippery road surfaces, such as snow or ice covered roads, may cause the rear wheels slipping to right or left. Therefore, please drive at low speed and operate carefully.

It is possible to build up a layer of water film between the tyre and road surface when driving on wet or slushy roads. This may prevent the steering and braking from operating properly. It is recommended that you enable ESP function on this occasion.

■ Driving out silt and ice and snow road

If drive wheel is stuck in silt or ice and snow, please attempt to shake vehicle at low speed and drive forward and backward repeatedly. Shift the shift lever between forward position and reverse position several times and depress accelerator pedal slightly. Avoid shifting the shift lever between forward position and reverse position for a long period of time, failure to do so may cause excessive transmission wear.

Tyre Chains

Purchase a set of tyre chains that match size of the vehicle tyres. Pay attention to the following precautions when installing and removing chains:

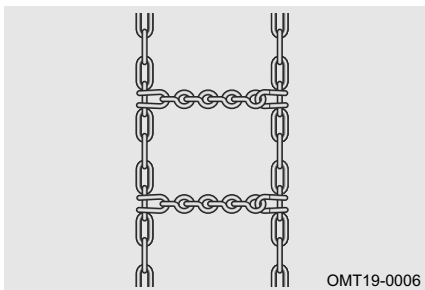

1. Follow local regulations when using chains;
2. Install and remove tyre chains in a safe location;
3. Install tyre chains by following the instructions provided;
4. Follow local regulations when using chains;

5. It is recommended to use the beef tendon chains or rubber chains with a thickness not exceeding 12 mm, otherwise, tyres, rims, drive system, brake system and wheel guard plates may be damaged. Vehicle damages resulting from improper use of chains are not covered by warranty;
6. Please consult authorized service centre for details about wheels, tyre size.

 CAUTION

Observe the following precautions to reduce the risk of accidents. Failure to do so may result in the vehicle unable to be driven safely, and may cause death or serious injury.

- Regulations regarding the use of tyre chains vary according to location and type of road. Always check local regulations before installing tyre chains;
- Be sure to use chains that are suitable for your vehicle. Installing chain will affect vehicle handling, please drive carefully. Using improper chains or improper installing of chains may cause an accident and lead to injuries;
- Please follow the instructions provided by the manufacturer of the chains to install and remove chains, vehicle should be parked in a safe place before installation and removal. Be sure to turn off the engine before installing chains (automatic transmission is in P position), place the traffic warning signs if necessary;
- Do not drive vehicle at more than 18 mph (30 km/h) when chains are installed on vehicle, or refer to the vehicle speed limit specified by the manufacturer of chains, whichever is lower. It should avoid dangerous road conditions such as bumps, potholes, sharp turns etc. when installing chains, do not turn steering wheel sharply, lock brake urgently, accelerate or decelerate suddenly etc.

1. INTRODUCTION

1-11. Cybersecurity Notice

Cybersecurity Support Service Update or Termination Notice

The company has provided cybersecurity support services in the corresponding software and equipment of the Internet of Vehicles service, and regularly or irregularly updates or terminates this service.

We can notify customers through website announcements, emails, in-vehicle systems, mobile phone text messages, voice calls, etc. according to the specific content of the notification.

Email, SMS, and voice calls will be sent to the email address and mobile phone listed in the customer's account registration information.

Cybersecurity Notice for Scrapping or Resale

Before you resell or scrap the vehicle, that is, when you no longer hold the vehicle, you should clear the personal information in the vehicle terminal by yourself.

The company does not assume any responsibility if the personal information of the vehicle terminal is leaked to a third party due to improper operation.

2-1. Instrument Cluster	Smart Vehicle Locating Function 43
Instrument Cluster View 22	Intelligent Headlight Function (IHC) 44
Operating the meter control buttons 24	Fogging Instructions for Light 44
Information Display Area 24	
2-2. Operation/Malfunction Indicator	2-7. Seats
Operation/Malfunction Indicator 27	Head Restraints 45
2-3. Steering Wheel	Front Seats 46
Horn 32	Second Row Seat 48
Heated Steering Wheel (If Equipped) 32	Seat Heating Function (If Equipped) 49
Adjusting Steering Wheel 33	2-8. Seat Belts
2-4. Rear View Mirror	Seat Belts 49
Automatic Inside Rear View Mirror 34	Seat Belt Pretensioner 54
Outside Rear View Mirror 34	2-9. Child Restraint Systems
2-5. Wiper System	Safety Instructions for Using Child Restraint System 55
Wiper Operation 35	Recommended Child Restraint Systems 57
Wiper Blade Replacement 37	Top Tether 58
2-6. Lighting System	Installing Child Restraint Systems 60
Exterior Lighting 39	Enabling and Disabling Front Passenger Airbag 64
Interior Lighting 42	Child Presence Detection in Rear Seat (If Equipped) ... 65
Follow Me Home Function 43	

2. PREPARATION FOR DRIVING

2-1. Instrument Cluster

Please refer to the actual vehicle for all display images.

Instrument Cluster View

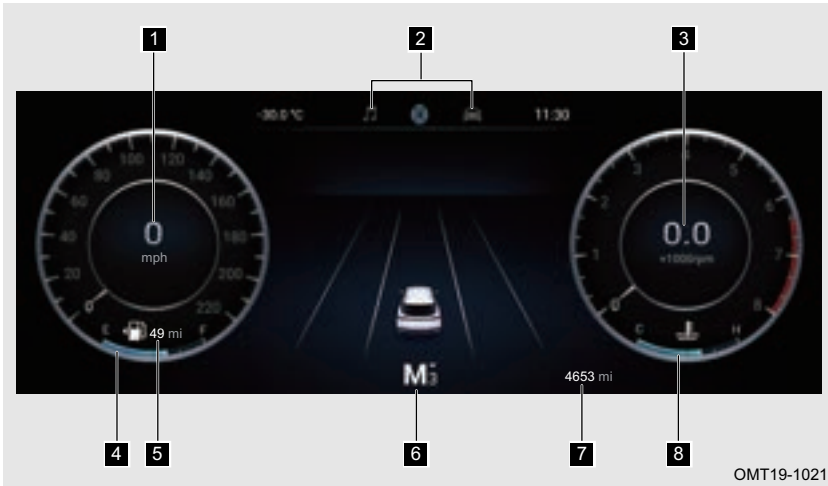

OMT19-1021

1 Speedometer: Current driving speed (unit: mph).

⚠ CAUTION

Speedometer is affected by tyre size used in vehicle. Only tyres of original size can be used (For details, refer to "Vehicle Specifications"), otherwise the speedometer will not indicate the correct speed.

2 Conventional display screen (status bar): Current conventional display screen information.

3 Tachometer: Current engine speed (unit: x1000 rpm).

After break-in period of vehicle, it is allowed to reach the high engine speed range of 6000 - 8000 rpm. Do not drive vehicle within this range for prolonged periods of time.

⚠ CAUTION

- Do not run engine at high speed during break-in period.
- Do not keep engine speed at 6000 rpm or more for prolonged periods of time, or engine may be seriously damaged.

4 Fuel gauge: Current remaining fuel of fuel tank.

When fuel gauge indication is near E or the low fuel level warning indicator remains on, it indicates that remaining fuel is insufficient. Please add fuel as soon as possible.

 READ

When the vehicle is accelerating, braking urgently, turning sharply or driving on a slope, the fuel gauge reading might be inaccurate.

5 Driving mileage: The estimated maximum distance that can be driven with current remaining fuel (common unit: mi). READ

Driving mileage is calculated by the on-board computer, it can only be used as a reference.

6 Gear position information: Currently selected gear position information (in manual mode or the current gear position).

On-board computer displays arrow and target gear according to current conditions to prompt user to perform a reasonable shift operation:

"▲" prompts you to perform an upshift operation.

"▼" prompts you to perform a downshift operation.

 READ

The information is for reference only. Always upshift or downshift according to actual situations.

7 Total mileage: Total mileage of the vehicle (common unit: mi).**8** Engine coolant temperature gauge: Current engine coolant temperature.

Low temperature range: Near C or in C area

When engine coolant temperature gauge is near C or in C area, it indicates that engine coolant temperature is low. Within this temperature range, do not run engine at high speed and the engine load should not be excessive.

Overheating range: Near H or in H area

When engine coolant temperature gauge is near H or in H area, it indicates that engine coolant temperature is high. Stop vehicle at a safe place away from major traffic, turn vehicle power to OFF mode after idling for several minutes. Please go to authorized service centre for inspection and repair immediately.

2. PREPARATION FOR DRIVING

CAUTION

- If engine coolant temperature gauge indication remains in low temperature range for prolonged periods of time, please go to authorized service centre for inspection and repair immediately.
- Never open the coolant reservoir cap if engine coolant temperature gauge indication is in overheating range. Check if coolant level is too low after engine cools down. Never run engine when coolant level is too low, or the engine will be seriously damaged.

Operating the meter control buttons

The display screen is operated using the meter control buttons.

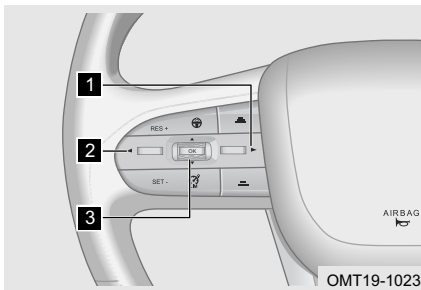

- 1 Right directional button
- 2 Left directional button
- 3 Confirmation button

Information Display Area

Conventional display screen

Conventional display screen includes the following screens, press right/left directional button briefly to scroll through the following screens.

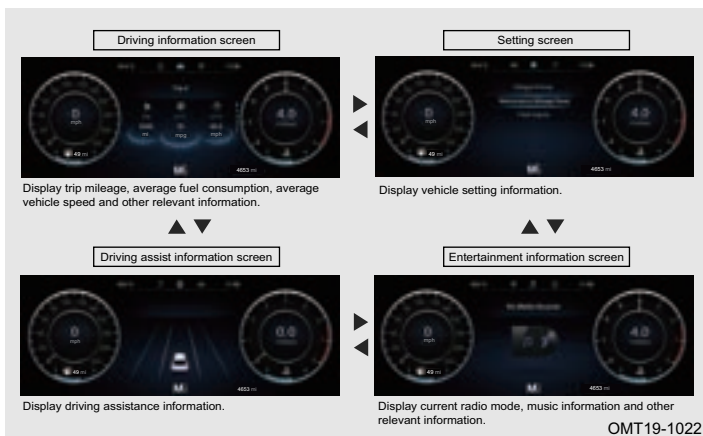

Driving information screen

On driving information screen, press confirmation button up or down to scroll through the following screens.

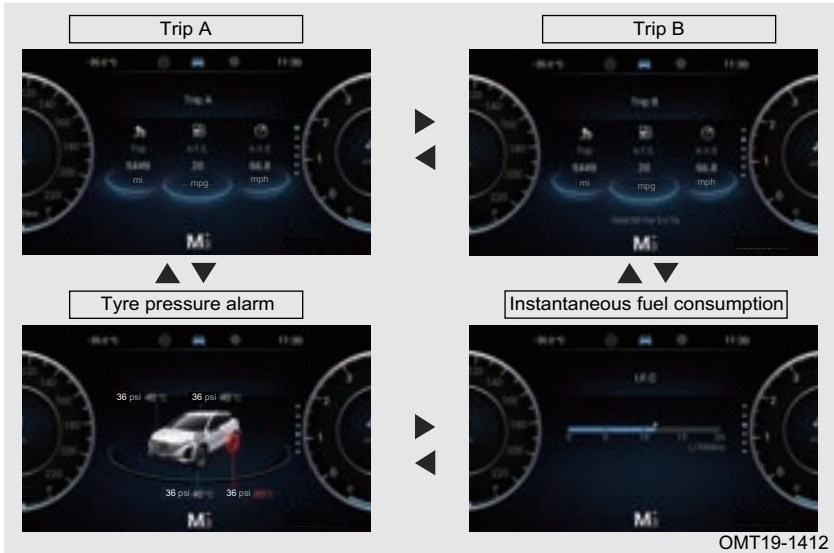

Setting

■ Fatigue Driving



Step 1: On setting screen, press confirmation button up or down to fatigue driving. Short press confirmation button to enter fault inquiry screen.

Step 2: On fatigue driving screen, press confirmation button up or down to select the time.

2. PREPARATION FOR DRIVING

■ Maintenance Mileage Reset



Step 1: On setting screen, press confirmation button up or down to maintenance mileage reset. Short press confirmation button to enter maintenance mileage reset screen.

Step 2: On maintenance mileage reset screen, press confirmation button up or down to Yes/No. Short press confirmation button to set.

■ Fault Inquiry

When on-board computer detects that the system is malfunctioning or its information is abnormal, the alarm information will be immediately displayed in information display area one by one and recorded in fault information screen after switching vehicle power to ON mode.



Step 1: On setting screen, press confirmation button up or down to fault inquiry. Short press confirmation button to enter fault inquiry.

Step 2: On fault inquiry screen, press confirmation button up or down to check related fault information.







2-2. Operation/Malfunction Indicator

Operation/Malfunction Indicator









The operation indicator is used to alert driver the operating condition of a certain vehicle's system and the corresponding operation indicator will remain on.









Malfunction indicator is used to alert driver that a certain system of the vehicle is malfunctioning, the corresponding malfunction indicator will come on or flash.

When vehicle power is turned to ON mode, some malfunction indicators will come on for a short time, indicating system is performing self-check. If one system malfunction indicator remains on or flashes after starting the engine, please contact authorized service centre for inspection and repair immediately.









Item	Indicator	Description
Position light indicator		When the position lights are turned on, the indicator comes on.
Directional signal light indicator		When the left or right indicator lights are turned on, the corresponding indicator signal light flashes. When hazard light switch is turned on, both left and right indicator lights will flash simultaneously.
Headlight high beam indicator		When the high beam lights are turned on or when the high beam lights flash, the indicator comes on.
Front fog light indicator		When Front fog light is turned on, the rear fog light indicator will come on.
Rear fog light indicator		When rear fog light is turned on, the rear fog light indicator will come on.
Intelligent headlight (IHC) indicator		This indicator is used to indicate that the vehicle's automatic headlights are in operating condition currently.
Intelligent headlight (IHC) malfunction indicator		This indicator is used to indicate that the vehicle's automatic headlights are malfunctioning currently. Please go to authorized service centre for inspection and repair as soon as possible.







2. PREPARATION FOR DRIVING

Item	Indicator	Description
low washer fluid level indicator		The indicator is used to remind the driver that washer fluid is low, please add as soon as possible.
Driver seat belt indicator		This indicator is used to alert the driver that the driver seat belt is not buckled or not fastened firmly. Wear seat belt and drive safely.
Front passenger seat belt indicator		This indicator is used to alert the driver that the front passenger seat belt is not buckled or not fastened firmly. Wear seat belt and drive safely.
Rear seat belt indicator		This indicator is used to alert the driver that the rear seat belt is not buckled or not fastened firmly. Wear seat belt and drive safely. Note: the red indicator light turns on when the corresponding seat belt is not fastened, and turns off when the corresponding seat belt is fastened.
Brake system malfunction indicator		This indicator is used to alert the driver that brake fluid level is low or brake system is malfunctioning. Please go to authorized service centre for inspection and repair immediately.
Electric Parking Brake (EPB) system indicator		This indicator comes on to indicate that the vehicle's EPB is in operating condition currently. The indicator flashes during sudden braking, it is normal and does not need to be dealt with. If it flashes in other cases, it indicates that the system is malfunctioning. Please go to authorized service centre for inspection and repair as soon as possible.
Electric Parking Brake (EPB) system malfunction indicator		This indicator is used to alert the driver that EPB is malfunctioning. Please go to authorized service centre for inspection and repair as soon as possible.
Automatic Parking System (AUTO HOLD) indicator		This indicator is used to indicate that the vehicle is in automatic parking condition currently.



Item	Indicator	Description
Electronic Stability Program (ESP) system indicator		<p>This indicator flashes to indicate that the vehicle's Electronic Stability Control (ESP) system is in operating condition currently.</p> <p>This indicator comes on to alert the driver that Electronic Stability Program (ESP) system is malfunctioning. Please go to authorized service centre for inspection and repair as soon as possible.</p>
ESP OFF indicator		When ESP function is turned off, ESP OFF indicator will come on, indicating that Electronic Stability Program (ESP) system is in disabled condition.
Low fuel level warning indicator		This indicator is used to alert the driver that vehicle is running out of fuel. Please add fuel as soon as possible.
Airbag (SRS) malfunction indicator		This indicator is used to alert the driver that Airbag (SRS) system is malfunctioning. Please go to authorized service centre for inspection and repair as soon as possible.
Charging system indicator		This indicator is used to indicate the operating condition of charging system. If this indicator does not come on when vehicle power is turned to ON mode, or comes on after engine starts, please go to authorized service centre for inspection and repair as soon as possible.
Engine warming up indicator		This indicator is used to alert the driver that when engine coolant temperature is too low, engine is in warming up currently. After coolant temperature rises, the indicator goes off to indicate that the engine warm-up is completed currently.
High coolant temperature warning indicator		This indicator is used to alert the driver that engine coolant temperature is high. Drive vehicle to a safe area and stop, turn vehicle power to OFF mode after idling for several minutes. Please go to authorized service centre for inspection and repair immediately.
Tyre pressure monitoring system		This indicator is used to indicate that tyre pressure is incorrect. Please check if tyre pressure is too low or if temperature is too high. If tyre pressure is normal, please go to

2. PREPARATION FOR DRIVING

Item	Indicator	Description
malfunction indicator		authorized service centre for inspection and repair as soon as possible.
Anti-lock Brake System (ABS) malfunction indicator		This indicator is used to alert the driver that Anti-lock Brake System (ABS) is malfunctioning. Please go to authorized service centre for inspection and repair as soon as possible.
EPC malfunction indicator		This indicator is used to alert the driver that engine system is malfunctioning. Please go to authorized service centre for inspection and repair immediately.
Engine malfunction indicator		This indicator is used to alert the driver that engine is malfunctioning. Please go to authorized service centre for inspection and repair immediately.
Transmission malfunction indicator		This indicator is used to alert the driver that transmission system is malfunctioning. Please go to authorized service centre for inspection and repair immediately.
Electric Power Steering (EPS) system malfunction indicator		This indicator is used to alert the driver that electric power steering system is malfunctioning. Please go to authorized service centre for inspection and repair immediately.
Low engine oil pressure warning indicator		This indicator is used to alert the driver that engine oil pressure is low. Drive vehicle to a safe area and stop. Please go to authorized service centre for inspection and repair immediately.
Automatic emergency braking system (AEB) indicator		This indicator is used to indicate that automatic emergency braking system (AEB) is in operating condition currently.
Automatic emergency braking		This indicator is used to indicate that automatic emergency braking (AEB) system is malfunctioning. Please go to authorized service

Item	Indicator	Description
(AEB) system malfunction indicator		centre for inspection and repair as soon as possible.
Automatic emergency braking (AEB) system OFF indicator		When AEB function is turned off, AEB OFF indicator will come on.
Lane departure warning (LDW) system indicator		This indicator flashes to indicate that the vehicle's lane departure warning (LDW) system is in operating condition currently. This indicator comes on to alert the driver that lane departure warning (LDW) system is malfunctioning. Please go to authorized service centre for inspection and repair as soon as possible.
Safety warning light		This malfunction light comes on to indicate that one of the vehicle's systems is malfunctioning currently. Please go to authorized service centre for inspection and repair as soon as possible.
Petrol Particulate Filter (PPF) indicator (if equipped)		This indicator comes on to alert the driver that Petrol Particulate Filter (PPF) is full, please increase the speed and clean it.
Petrol Particulate Filter (GPF) malfunction indicator (if equipped)		This indicator comes on to alert the driver that Petrol Particulate Filter (PPF) is malfunctioning. Please go to authorized service centre for inspection and repair as soon as possible.
Driver monitor system indicator		This indicator comes to indicate that the driver monitor system is activated.

2. PREPARATION FOR DRIVING

Item	Indicator	Description
Driver monitor system malfunction indicator		This indicator comes to indicate that the driver monitor system is malfunctioning. Please go to authorized service centre for inspection and repair as soon as possible.
Maintenance indicator		This indicator is used to alert the driver that the vehicle needs maintenance. Please go to authorized service centre for inspection and repair as soon as possible.

2-3. Steering Wheel

Horn

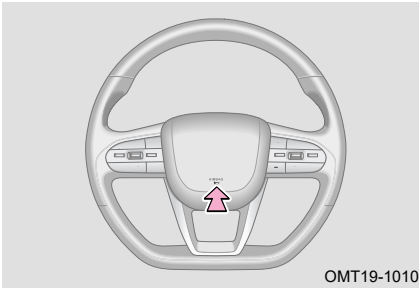

To sound the horn, press area near horn mark on the steering wheel.

READ

Obey local regulations regarding usage of vehicle horns.

Heated Steering Wheel (If Equipped)

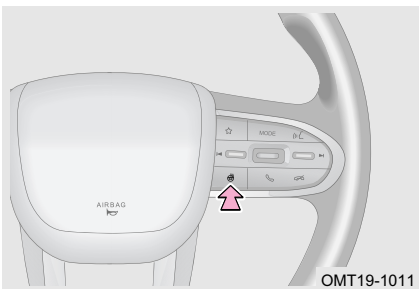

Press the switch to enable steering wheel heating function and indicator comes on at the same time. Press the switch again to cancel the function and the indicator turns off.

⚠ CAUTION

When the following conditions are met, the steering wheel heating function will be turned on:

- Engine is operating.
- Voltage of battery is in normal range.
- Steering heated switch is pressed.

When any of the following conditions is met, the function will turn off after it works for a period of time:

- Engine stops.
- Steering wheel is heated over 25 minutes.
- Steering heated switch is pressed again.
- When temperature of steering wheel is over 34°C, steering wheel heating function turns off; After that, when temperature of steering wheel is below 30°C, the function recovers.

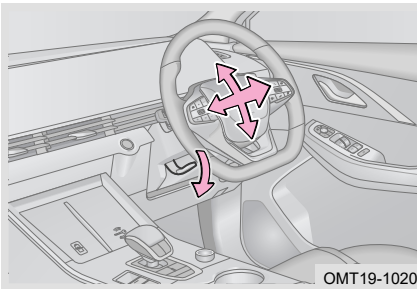
Adjusting Steering Wheel

Stop vehicle at a safe place away from major traffic, turn vehicle power to OFF mode :

Step 1: Push down adjustment lever and release it;

Step 2: Adjust steering wheel up or down/forward and backward to a comfortable angle;

Step 3: Hold steering wheel steady and push adjustment lever to original position;

Step 4: Check if the steering wheel is shaking. Repeat operations of step 3 if shaking.

⚠ WARNING

- Make sure the steering wheel is securely locked before driving, otherwise it may cause accidents and personal injury.
- Do not adjust steering wheel while driving, otherwise it may cause accidents and personal injury.

2. PREPARATION FOR DRIVING

2-4. Rear View Mirror

Automatic Inside Rear View Mirror

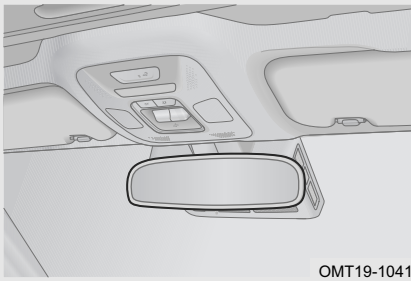

When driving at night, the light sensor installed in front/rear of the inside rear view mirror automatically detects the reflected light from the headlights of vehicles behind and automatically adjusts the lens angle to reduce the reflected light from the headlights of vehicles behind.

Outside Rear View Mirror

Adjusting outside rear view mirror

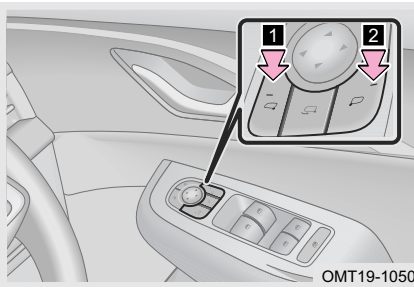

Stop vehicle at a safe place away from major traffic, turn vehicle power to ON mode:

Step 1: To select a mirror to adjust, press the switch. The indicator on the switch illuminates, Pressing again will turn off the indicator.

1 Left

2 Right

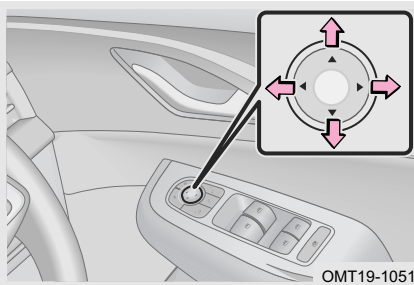

Step 2: To adjust the mirror, press the adjustment switch.

↑ Up

↓ Down

← Left

→ Right

WARNING

- Do not adjust outside rear view mirror while driving, otherwise it may cause accidents and personal injury.
- Image displayed on outside rear view mirror may differ from the actual, so always drive carefully.

Folding/extending outside rear view mirror

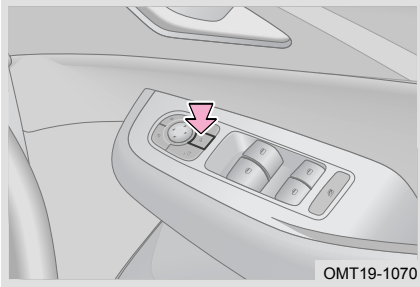

Operate using switch: When vehicle power is turned to ON mode, press outside rear view mirror folding switch to fold mirrors automatically, press the switch again to extend mirrors automatically (do not fold manually).

Operate using key: In arming/disarming mode, outside rear view mirror will fold/extend automatically.

READ

- Outside rear view mirror automatic folding needs to be set in audio system. For details, refer to "Audio System".
- According to visual field requirements, folding angles of the left and right mirrors are different. Therefore, when outside rear view mirrors automatically fold, the left and right mirrors are not synchronized, which is normal.

CAUTION

- Do not fold/extend the power outside rear view mirror manually, otherwise it may cause the folding function to fail.
- When folding/extending the outside rear view mirror, do not touch its surface to prevent damage to it with excessive force.
- In cold weather, it is recommended to turn off the outside rear view mirror automatic folding function. This will prevent the outside rear view mirror from being frozen in folding position due to accumulated snow or rain.

2-5. Wiper System

Wiper Operation

Wiper stalk switch

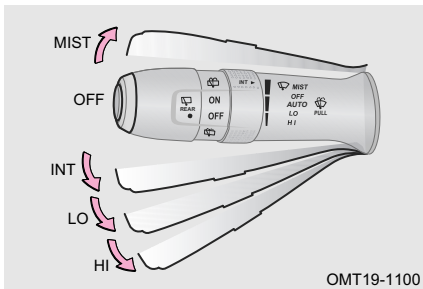

Turn vehicle power to ON mode, move the wiper stalk switch:

Mist mode "MIST": Wipers will stop after wiping once.

Low speed mode "LO": Operate slowly and continuously.

High speed mode "HI": Operate quickly and continuously.

2. PREPARATION FOR DRIVING

Stop mode "OFF": Operate automatically at low speed until wipers return to stop position.

Auto mode "AUTO": Control the wiping speed of the wiper according to amount of rainfall.

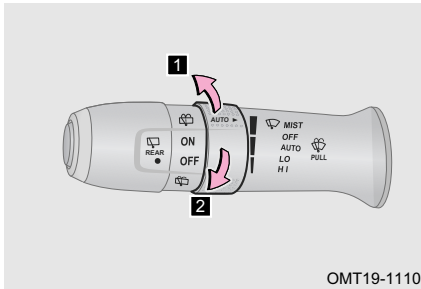

When AUTO mode is selected, the sensor sensitivity can be adjusted by operating the switch.

- 1** Decreases the sensitivity
- 2** Increases the sensitivity

CAUTION

- Do not operate wiper when the windshield is dry, as this may damage wiper blade or scratch the windshield.
- Do not operate wipers if there are obstacles on windshield, as this may scratch the windshield and damage wiper motor.
- In cold weather, always check if wiper blade is frozen onto windshield before using wipers. If so, defrost before using, otherwise it may damage wiper blade and wiper motor.

Front washer operation

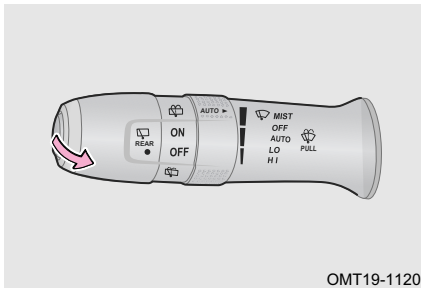

Turn vehicle power to ON mode, pull wiper stalk switch towards the steering wheel and hold, the front washer sprays water, and front wiper operates simultaneously. Front wiper will stop operating when the switch is released, the wiper will wipe 3 cycles at low speed, and operate one cycle then stop after a few seconds.

Rear washer operation

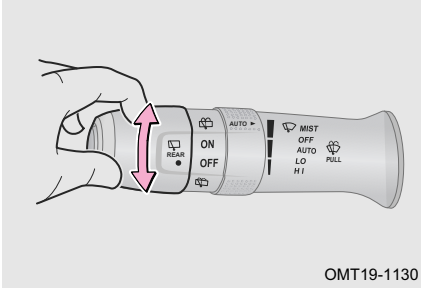

Turn vehicle power to ON mode and operate wiper stalk switch.

: rear washer sprays water, and rear wiper operates simultaneously. After releasing, they stop working.

ON: rear wiper is turned on.

OFF: rear wiper is turned off.

: rear washer sprays water, and rear wiper operates simultaneously. After releasing, they stop working.

CAUTION

- Do not operate wiper stalk switch when there is no washer fluid in reservoir.
- When operating wiper stalk switch to spray water, do not exceed 10 seconds at a time.
- Do not try to clear a nozzle with a pin or other objects when it becomes blocked, or it will be damaged.
- The antifreeze will corrode any painted surface, so be careful when adding washer fluid.
- Do not mix water with the washer. Water may cause the solution to freeze and damage the washing tank and other parts of the washer system.

Wiper Blade Replacement

Replacing front wiper blades

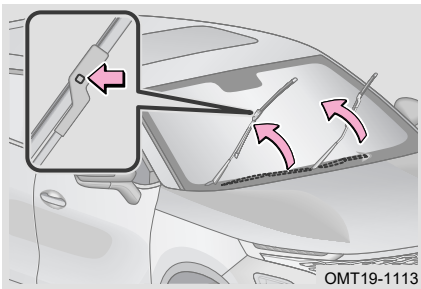

Step 1: Operate the front wiper switch within 3 seconds after turning off the engine start stop switch, the wiper will enter repair mode;

Step 2: Lift the front wiper arm and hold;

Step 3: Push wiper blades outward while pressing the lock button to remove the blades;

Step 4: Install the new wiper blades in reverse order, and make sure the fixing clamp is locked firmly;

Step 5: Check that front wipers operate properly.

2. PREPARATION FOR DRIVING

Replacing rear wiper blade

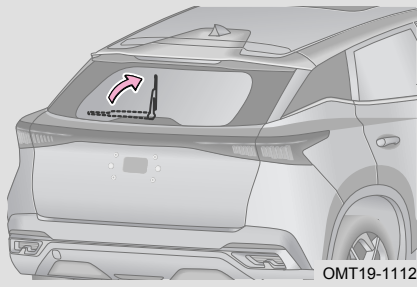

Step 1: Lift the rear wiper arm and hold;

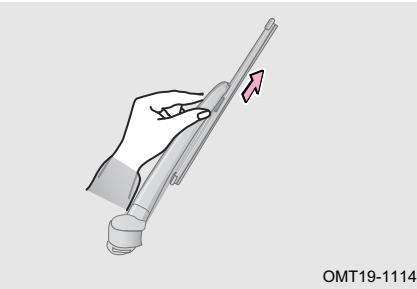

Step 2: Separate the wiper blade by hand as shown in the illustration;

Step 3: Install the new wiper blade in reverse order, and be sure to install them in place;

Step 4: Check that rear wiper operates properly.

READ

It is recommended you have wiper blades replaced by someone at authorized service centre to ensure correct fitting.

CAUTION

Make sure the wiper arm returns to its original position before driving, otherwise it may damage the vehicle and cause an accident.

2-6. Lighting System

Exterior Lighting

Headlight stalk switch

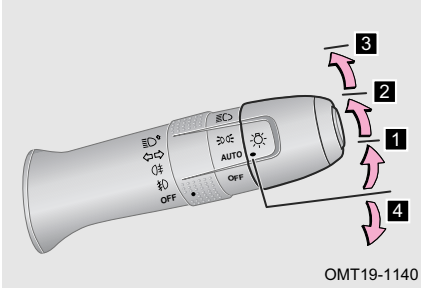

Turn vehicle power to ON mode, operate headlight stalk switch:

1 AUTO: Automatically senses the intensity of external light, turn on/off position lights, license plate lights, ambient lights and low beam lights.

2 ON: Turn on front and rear position lights, license plate lights, ambient lights and backlights.

3 LOW BEAM: Turn on headlight low beam lights and keep position light on.

4 OFF: Turn off headlight.

READ

When parking vehicle for prolonged periods of time or before leaving vehicle, make sure that headlight stalk switch is turned off to prevent the battery from being depleted. Failure to do so may cause the vehicle not to start.

Headlight high beam

High beam lights

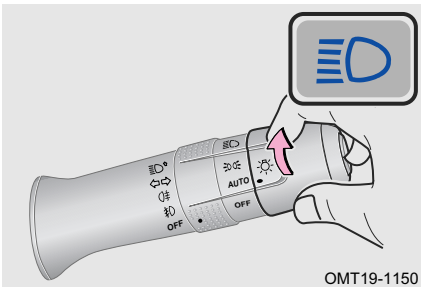

When turning on low beam light, pull headlight stalk switch away from steering wheel side and release, headlight high beam comes on; Pull headlight stalk switch towards steering wheel side and release to turn off headlight high beam.

2. PREPARATION FOR DRIVING

■ High beam lights flash

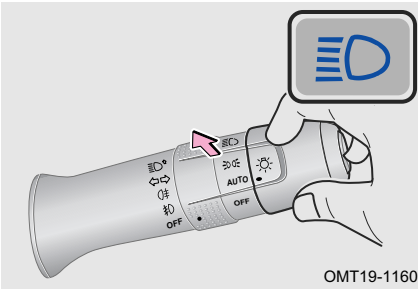

Pull headlight stalk switch towards the steering wheel and release it to flash the high beam lights once. At the same time, headlight high beam indicator in instrument cluster flashes once.

READ

High beam light can flash when the low beam light is off.

Directional indicator lights

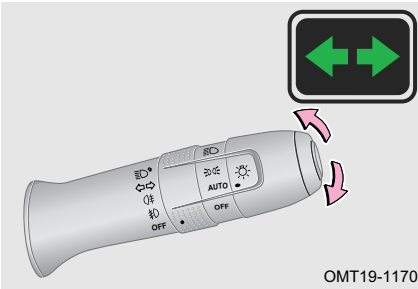

Turn vehicle power to ON mode, switch headlight stalk switch :

Pull up: Left indicator signal lights come on.

Pull down: Right indicator signal lights come on.

When indicator signal lights are turned on, the indicator will flash in the instrument cluster. As vehicle is turning back after turning, stalk switch automatically returns to center position.

■ Lane change assist function

Turn vehicle power to ON mode, pull directional indicator light switch once but not too far over. This will make the indicator flash 3 times.

READ

During a slight steering wheel turn, headlight stalk switch may not automatically return to original position.

Front fog lights

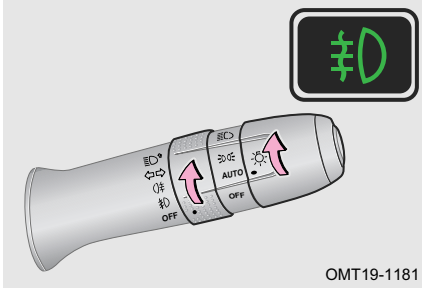

Turn vehicle power to ON mode, when position lights turn on, operate fog light switch to "ON" position to turn on front fog lights; Turn vehicle power to OFF mode or operate fog light switch to "OFF" position again, front fog lights turn off.

■ Assist steering lighting

When the vehicle power is in ON mode and the speed is lower than 24 mph (40 km/h), front fog lights will come on when the indicator signal lights are turned on or steering wheel is turned more than 40° and low beam light is turned on.

Turn off the assist steering lighting function when any of the following conditions are met:

- Vehicle power is in ACC or OFF mode.
- Turn off the indicator signal light or turn the steering wheel below 10°.
- Turn off the low beam light.
- Vehicle speed is higher than 24 mph (40 km/h).

Rear fog light

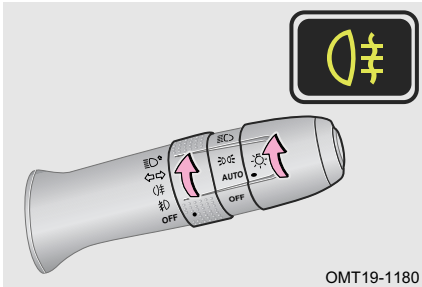

Turn vehicle power to ON mode, when front fog light or low beam lights turn on, operate fog light switch to "ON" position to turn on rear fog light; After turning vehicle power to OFF mode or operate fog light switch to "OFF" or "OFF" position again, rear fog light turns off.

READ

- When turning off front fog lights or low beam lights, rear fog light turns off at the same time.
- Obey local regulations regarding usage of fog lights.

Daytime running lights

When the engine is started, the low beam lights, high beam lights and front fog lights position lights are not turned on, the daytime running lights are turned

2. PREPARATION FOR DRIVING

on. Daytime running lights turn off automatically when position lights are turned on.

Ground lights (if equipped)

When unlocking or locking the vehicle, ground lights will come on for 15 seconds; when opening any door, ground lights will come on for 3 minutes.

Brake lights

Depress the brake pedal, brake lights and high mounted brake light turn on.

Reverse lights

Turn vehicle power to ON mode, shift the shift lever to R, reverse lights turn on.

License plate lights

Turn vehicle power to ON mode and rotate headlight stalk switch to "☞☞" position to turn on license plate lights. They are used to illuminate license plate in the dark.

Interior Lighting

Front dome lights

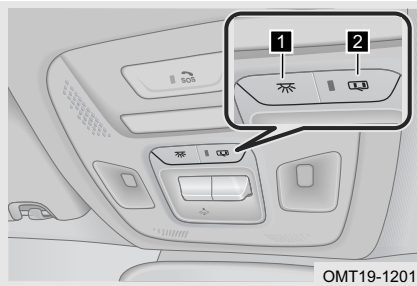

- 1** Reading lights switch: Press "☞☞" switch to turn reading lights on, press the switch again to turn reading lights off.
- 2** Door control switch: Press "☞☞" switch, if any door is opened and keep opening, dome lights will be on for 3 minutes (fade in and out).

Rear dome lights (if equipped)

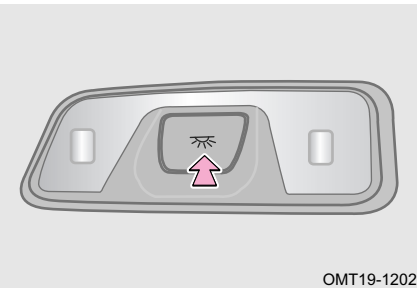

Press rear dome light switch, the light comes on, press the switch again to turn off light.

Luggage compartment light

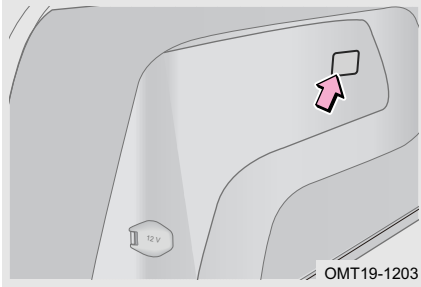

When boot door is opened, luggage compartment light will turn on for 15 seconds automatically. When boot door is closed, luggage compartment light will turn off immediately.

Follow Me Home Function

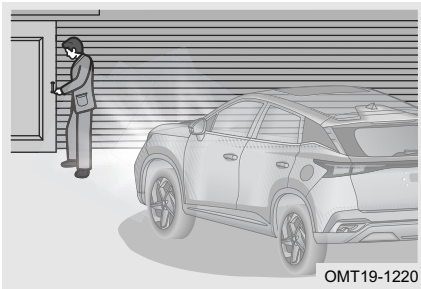

ON: Turn vehicle power to OFF mode, and turn the headlight stalk switch to "AUTO" position. When the vehicle is in a dim environment, press lock button on smart key, vehicle is armed successfully. Low beam lights automatically come on for 27 seconds. Press lock button on smart key to activate it again.

OFF: When vehicle power is turned to ACC/ON, press unlock button on smart key, the headlight stalk switch is not in "AUTO" position or reaches the set operating time, the follow me home function will be turned off automatically. Low beam lights will go off immediately.

READ

Follow me home function needs to be set in audio system (for details, refer to "Audio System").

Smart Vehicle Locating Function

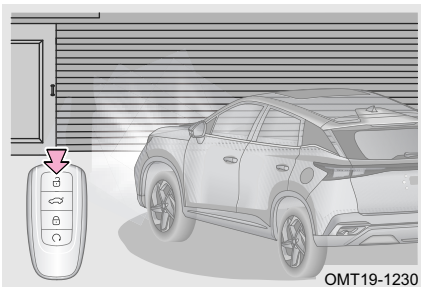

Turn the headlight stalk switch to "-AUTO" position before stopping. When the vehicle is in a dim environment, press unlock button on smart key, the low beam lights come on for 27 seconds.

2. PREPARATION FOR DRIVING

Intelligent Headlight Function (IHC)

Turn vehicle power to ON mode, and turn the headlight stalk switch to "AUTO" position. When the low beam light turns on automatically, pull the headlight stalk switch away from steering wheel side and release. When the vehicle speed exceeds 24 mph (40 km/h), the white indicator "☰△" in instrument cluster remains on, and the intelligent headlight function (IHC) is activated; At this time, the intelligent headlight function (IHC) automatically turns headlight high beam on/off according to road conditions, such as meeting, following, and overtaking.

When the intelligent headlight function (IHC) is activated, the headlight high beam turns on or flashes, the white indicator "☰△" in instrument cluster goes out. Pull the headlight stalk switch away from the steering wheel side and release, intelligent headlight function (IHC) is reactivated.

READ

- When the vehicle speed is less than 18 mph (30 km/h), the intelligent headlight function (IHC) turns off the headlight high beam automatically.
- When the ambient brightness is too high, the intelligent headlight function (IHC) turns off the headlight high beam automatically.
- When the left/right indicator signal light is activated, the intelligent headlight function (IHC) can not turn the headlight high beam on/off automatically.
- Intelligent headlight function (IHC) needs to be set in audio system. For details, refer to "Audio System".

Fogging Instructions for Light

When the weather is cold or humid, the inner side of lights will fog up due to the difference in temperature between the inside and outside. After lights turn on for a period of time, the fog inside the lights will gradually disappear, and there may still be some fog at the edge of the lights. This is normal. This fog has no effect on service life of lighting system. The vehicle lights generate fog, which gradually begins to disappear in the lights of the headlight within 30 minutes after the low and high beam lights are turned on. After a period of lighting, the moisture disappears naturally. This is normal.

⚠ WARNING

- Following guidelines for driving through water (for example: water depth, speed, etc.) to avoid any water entering the lights.
- After opening light dust cover, reinstall it in place at the end of operation, otherwise water may enter the lights.
- When replacing a bulb, strictly check installation of various light components to make sure that they are installed correctly and sealed properly. When installing rear cover, check its seal ring and keep it clean! Otherwise, it will lead to water and dust entering lights!
- It is strictly forbidden to flush the engine compartment with a high pressure washer, in particular, the lights cannot be flushed. Due to high pressure of a pressure cleaner, accessories on lights may be loose or fall off, vent hole and wire harness connector may damp, resulting in water infiltration or moisture not dispersing for prolonged periods of time, and even severe condensation.

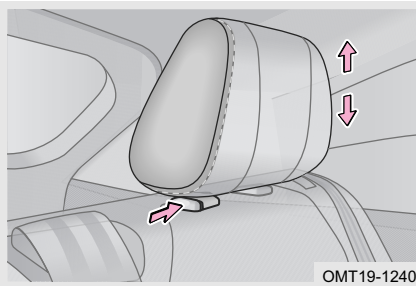
2-7. Seats**Head Restraints**

Adjust head restraint upward: Pull it up directly to a proper height.

Adjust head restraint downward: Push the head restraint down while pressing the lock release button.

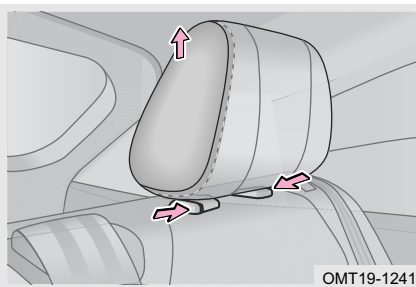

Removing head restraints: Pull the head restraint up completely while pressing 2 lock release buttons.

Installing head restraints: Align the head restraint with the installation holes and push it down to lock position. Press and hold the lock release button when lowering the head restraint.

2. PREPARATION FOR DRIVING

WARNING

- Do not adjust head restraints while driving, otherwise it may cause accidents and personal injury.
- Make sure the head restraint is securely locked before driving, otherwise it may cause accidents and personal injury.

Front Seats

Correct sitting posture

The seats, head restraints, seat belts and airbags are helpful to protect passengers. Using them correctly will provide you with more protection.

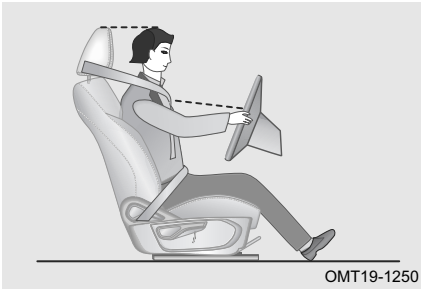

When sitting, sit slightly inclined backwards (25° backward from vertical position is ideal) and well back on seatback.

The front seats must not be too close to the instrument panel. The driver should hold the steering wheel with slightly bent arms during driving. Their feet should also be bent slightly so that they can fully depress the pedal. Adjust head restraints properly so that the top of the head restraint is closest to the top of your head.

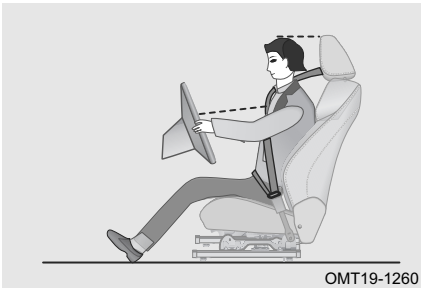

The shoulder belt should be over the center of the shoulder and close to the chest, kept away from the neck, the lap belt should lie over the hips instead of stomach.

Front passenger manual seat

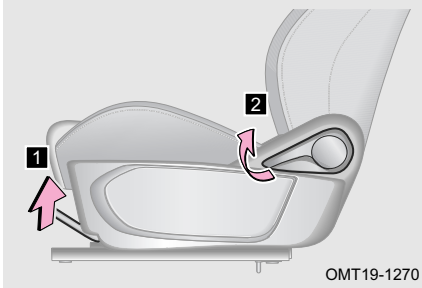

1 Adjusting seat position forward and backward

There is a grip under seat for adjusting forward and backward position of seat. Pull the grip up and move the seat back and forth to adjust forward and backward position of seat. After adjusting seat to a desired position, release the grip. Then, move the seat forwards and backwards to make sure that the seat is locked properly.

2 Seatback angle adjustment

Lean your body against seatback, and then pull seatback adjustment lever upwards. Adjust seatback to desired angle by changing tilt angle of your body. Once desired angle is reached, release the lever. After that, push backwards against the seatback to make sure that the seatback is locked properly.

Power seat

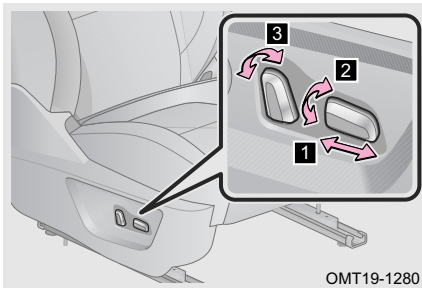

1 Adjusting seat position forward and backward

Move button forward and backward to adjust the seat back and forth.

2 Adjusting seat height (only driver side)

Move rear end of button up or down to adjust seat up or down.

3 Seatback angle adjustment

Move upper end of button forward and backward to adjust seatback angle.

Front seat front and back positions and seatback angle adjustable range (- Following data are applicable to power and manual seats):

The total adjustable front and rear range is 240 mm: When at designed position, it can be adjusted 200 mm forward and 40 mm backward; The driver's seat height can be adjusted by a range of 60 mm: When at designed position, it can be adjusted 40 mm upward and 20 mm downward; The seatback designed angle is 25°; When at designed angle, it can be adjusted 30° forward and 52° backward.

Note: When measuring the seat depth, seats and seatbacks should be adjusted to the original (designed) positions.

2. PREPARATION FOR DRIVING

CAUTION

Do not place any items under the seat while moving the seat, otherwise it will damage the seat.

WARNING

- Do not adjust seat while driving, otherwise it may cause accidents and personal injury.
- Avoid reclining seatback any more than needed, the seat belts provide maximum protection in a frontal or rear collision when the driver and the front passenger sit inclined slightly backwards and well back in their seats.

Second Row Seat

Folding seatback (both seats are folded in the same way)

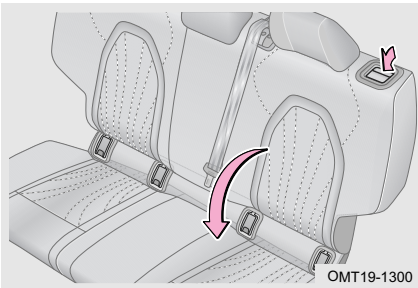

Adjust height of seat head restraints, remove them if necessary and fold up center armrest. Then pull the left seatback adjustment handle forward and pull seatback forward to fold it down slowly. This can enlarge the luggage storage space.

READ

When folding seatback, make sure that outer seat belt passes around the seatback to avoid damaging the belt.

WARNING

Do not adjust seat while driving, otherwise it may cause accidents and personal injury.

The seat front and back positions and seatback angle of the second row seats are not adjustable: The designed angle of the seatback is 25°.

Seat Heating Function (If Equipped)



OMT19-1301

Method 1: After starting the vehicle, first click seat heater button on the air conditioning display screen is 3-level heating (3 indicators on). Each time the switch is clicked, the heating level is lowered one level. Click it the fourth time to turn off the seat heating.



OMT19-1304

Method 2: After starting the vehicle, first press seat heater switch on the auxiliary fascia console is 3-level heating (3 indicators on). Each time the switch is pressed, the heating level is reduced by one level. Press it the fourth time to turn off the seat heating.

READ

Front seat heating and front seat ventilation cannot be turned on simultaneously.

2-8. Seat Belts

Seat Belts



OMT19-1320

We strongly recommend the driver and passengers wear their seat belts correctly at all times. Failure to do so could increase possibility and severity of injury in an accident. Check the seat belt regularly. If any seat belt function failure is found, please contact authorized service centre for inspection and repair immediately.

If driver seat belt is not buckled or fastened firmly: When vehicle speed is less than 15 mph (25 km/h), red indicator "⚠" in instrument cluster turns on; When vehicle speed is 15 mph (25 km/h) or more, the red indicator "⚠" in instrument cluster flashes, accompanied by sound alarm.

2. PREPARATION FOR DRIVING

If front passenger seat belt is not buckled or fastened firmly: When vehicle speed is less than 15 mph (25 km/h), red indicator "安全带" in instrument cluster turns on; When vehicle speed is 15 mph (25 km/h) or more, the red indicator "安全带" in instrument cluster flashes, accompanied by sound alarm.

If the rear seat belt is not buckled or fastened firmly: When vehicle speed is 15 mph (25 km/h) or more, the indicator "安全带" in instrument cluster flashes for 30 seconds and then remains on, accompanied by sound alarm.

Note: the red indicator light turns on when the corresponding rear seat belt is not fastened, and turns off when the corresponding rear seat belt is fastened.

READ

When the rear seat belts are not fastened, the red indicator in instrument cluster is on. After one of the rear seat belts is fastened, the green indicator is on. When all the seat belts are fastened, the indicator light goes out.

Using seat belt correctly

Step 1: Adjust the height of front seat belts;

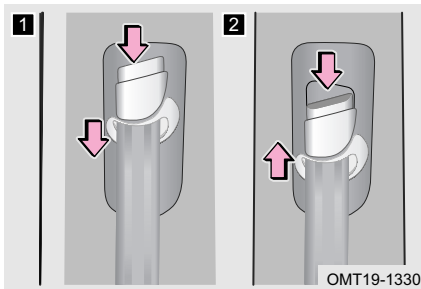

1 Adjust downward: Push seat belt adjustment button downward while pressing adjusting button.

2 Adjust upward: Push seat belt adjustment button upward while pressing adjusting button.

Step 2: Fasten/release seat belt;

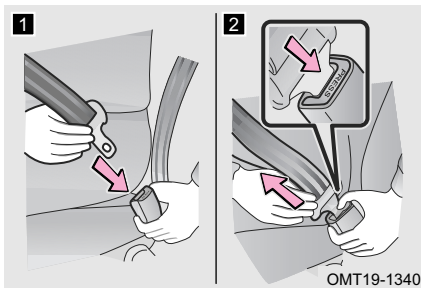

1 Fastening seat belt: Push the tab into the buckle until a "click" sound is heard.

2 Releasing seat belt: Press the release button to retract seat belt. If the belt cannot retract smoothly, pull it out and check for kinks or twists. Make sure that seat belt can retract smoothly.

READ

- Each seat belt shall be used by one person only. Do not use a seat belt for more than one person at one time, including children.
- The seat belt will lock when it is pulled out quickly or the vehicle is on a slope, but it will not lock when pulling it out slowly.

CAUTION

- Make sure that seat belt buckle position is correct and is locked safely, otherwise it may cause personal injury.
- Do not use any seat belt with a loose buckle, otherwise, the seat belt will not protect the passengers in the event of sudden braking or a collision.

Step 3: Adjust the position of seat belts.

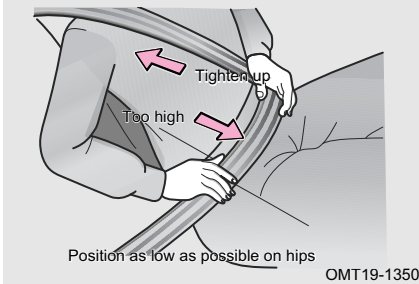

To adjust the seatback angle, sit up straightly and well back in the seat. Position the lap belt as low as possible on your hips — not on your waist, then pull the shoulder section upward so that it comes fully over the shoulder, but does not come into contact with the neck or slide off the shoulder.

CAUTION

- We recommend that children be seated in the rear seat and always use seat belt or appropriate child restraint system.
- Avoid loose fitting clothes when driving. These can prevent the seatbelt fitting correctly and can affect the protection offered.
- Do not recline seat more than necessary to achieve a comfortable ride. Seat belts are most effective when passengers are sitting up straight and well back in their seats.
- Make sure the shoulder belt is positioned across your shoulder. Do not place the shoulder belt under your arm. The belt should be kept away from your neck, but not falling off your shoulder. Failure to do so could reduce the protection effect of seat belt in an accident.
- Both high-positioned lap belts and loose-fitting belts could cause death or serious injuries during a collision.

Three-point seat belt for the second row center seat

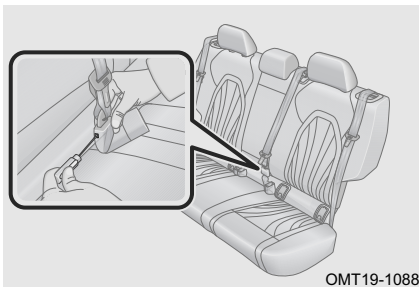

When inserting the small tab into the small buckle of left side of the second row seat, use a screwdriver with its tip wrapped with tape or similar object to press the position shown in illustration and pull out the small tab.

2. PREPARATION FOR DRIVING

READ

When the seatback is folded, three-point seat belt for the second row center seat needs to be released, otherwise it may lock and cannot be pulled out.

Maintaining seat belt

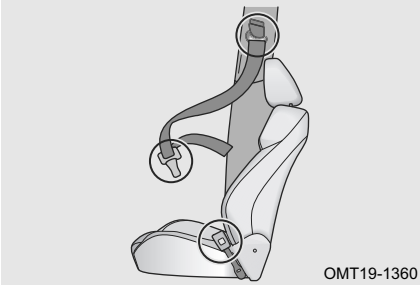

Check seat belts regularly for cuts, fraying, loose and stretched belt (- such as after a traffic accident) If the seat belt is damaged, please contact authorized service centre for inspection and repair immediately.

CAUTION

- Do not allow water to penetrate belt retractor or buckle mechanism.
- Never use chemical detergent, boiling water, bleach or dye to wash the seat belt.
- The seat belt should be washed with mild cleanser or warm water and dry naturally. Never clean it with artificial heat.
- Do not try to repair or lubricate retractor or buckle mechanism of seat belt, or repair seat belt in any way, we will not be held liable for any problem caused in this way.

WARNING

- If your vehicle has been involved in a serious accident and even if seat belt is not obviously damaged, you should contact authorized service centre for inspection and repair.
- Ensure that the belt and the tab are locked and the belt is not twisted. If the seat belt does not function properly, please contact authorized service centre for inspection and repair immediately.
- Do not attempt to install, remove, modify, disassemble or dispose of the seat belts. Have any service done to the seat belts by authorized service centre.

Seat belt precautions

■ Precautions for using seat belt by a child

The seat belts of your vehicle are principally designed for people of adult size. Use a child restraint system (For details, refer to "Child Restraint System" in this section) appropriate for the child, until the child becomes large enough to properly wear the vehicle seat belt. When the child becomes large enough to

properly wear the vehicle seat belt, follow the instructions regarding seat belt usage. If a child is too large to use a child restraint system, the child should sit in the rear seat and must be restrained using the vehicle seat belt.



Make sure the shoulder belt is positioned across the center of child's shoulder. The belt should be kept away from child's neck, but not falling off child's shoulder. Otherwise, the child is at risk of serious injury or even death during a collision.

Failure to use a child restraint system (for example: Let a child stand or kneel on seats; Let a child sit on an adult's laps; Holding a child in arms). This may cause death or serious injuries during a collision.

■ Precautions for using seat belt by a pregnant woman

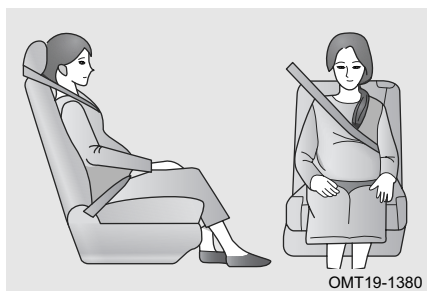

Obtain medical advice and wear the seat belt properly. Women who are pregnant should position the lap belt as low as possible over the hips in the same manner as other occupants. Extend the shoulder belt completely over the shoulder and across the chest, avoid belt contact with the abdominal area. If the seat belt is not worn properly, it may cause serious injuries or death during a collision.

⚠ WARNING

- After inserting the tab, make sure that the tab and buckle are locked and that the lap and shoulder belt are not twisted.
- Do not insert coins, clips, etc. into the buckle to prevent from properly latching tab and buckle.
- If the seat belt does not function normally, it cannot protect passengers from death or serious injury, please contact authorized service centre for inspection and repair immediately.

2. PREPARATION FOR DRIVING

Seat Belt Pretensioner

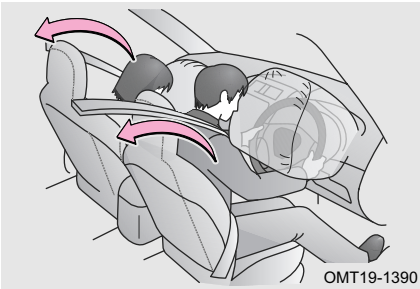

1. Seat belt pretensioner is designed to assist airbag in the event of a severe impact.
2. In the event of a minor impact or side impact, pretensioner may not be activated.
3. During a severe impact, seat belt pretensioner may be activated even if there is no occupant in front seat.
4. When seat belt pretensioner is activated, retractor quickly tightens seat belt to tightly restrain occupant.
5. When seat belt pretensioner is activated, it may make a working sound and release a small amount of non-toxic gas. The gas produced does not cause a fire and is generally harmless.

WARNING

- When seat belt pretensioner is activated, the airbag malfunction indicator remains on, and seat belts cannot be retracted / pulled out. Please contact authorized service centre for inspection and repair immediately.
- Do not modify, remove, hit or open the seat belt pretensioner assembly, airbag sensor and assembly wire. Otherwise, it may cause death or serious injuries during a collision.

Function limit

In the following cases, the seat belt pretensioner may not work properly:

- Modify suspension system.
- Modify front body section.
- Repair the seat belt pretensioner or any assembly nearby.
- Seat belt pretensioner assembly or its surrounding area is damaged.
- Install grill guard or any other device to front body.

2-9. Child Restraint Systems

Safety Instructions for Using Child Restraint System

In order to avoid serious injury caused by incorrect riding of children in an accident, children must sit in child restraint system when riding in vehicle.

Before installing and using child restraint system, please read the instruction manual of child restraint system carefully. In addition, local laws and regulations on children riding in vehicle should be observed.

For safety, it is recommended that the child restraint system is installed on the rear seat.

⚠ WARNING

When using the child restraint system, be sure to read the installation instructions contained therein and ensure that it is firmly installed.

Classification of child restraint system

Child restraint system purchased by user in Asean countries should comply with UN R44/UN R129 standard

■ Child restraint systems are divided into the following weight groups:

Weight Groups	Child Weight
Group 0	0 to 10 kg
Group 0+	0 to 13 kg
Group I	9 to 18 kg
Group II	15 to 25 kg
Group III	22 to 36 kg

- Weight group 0/0+: Apply to Group 0/0+ or Group 0/I rear-facing infant seat;
- Weight group I: Apply to Group I or Group II child restraint system with built-into seat belt system;
- Weight group II/III: Group II applies to child restraint system with seatback, Group III applies to child restraint system without seatback.

2. PREPARATION FOR DRIVING

■ Applicable child restraint system for passenger seat

Weight Groups	Front Passenger Seat (Airbag Switch ON)	Front Passenger Seat (Airbag Switch OFF)	Second Row Outside Seat	Second Row Center Seat
Group 0 (0 to 10 kg)	X	U/L	U/L	U
Group 0+ (0 to 13 kg)	X	U/L	U/L	U
Group I (9 to 18 kg)	X	U/L	U/L	U
Group II (15 to 25 kg)	X	U/L	UF/L	UF
Group III (22 to 36 kg)	UF	U/L	UF/L	UF

- L: If the vehicle is listed in applicable model list of the child restraint system manufacturer, it is suitable for child restraint systems of "semi-universal" categories approved for use in this weight group;
- U: Suitable for child restraint systems of "universal" categories approved for use in this weight group;
- UF: Suitable for front-facing child restraint systems of "universal" categories approved for use in this weight group;
- X: Not suitable for installing any type of child restraint systems in this weight group.

Note: Child restraint systems of "universal" class: It is installed with seat belt for adult; Child restraint systems of "semi-universal" class: It is installed by with ISOFIX anchor point and top tether strap anchorage.

Note: When installing CRS on the front passenger seat, ensure the seat is fully rearward.

Child Restraint System Precautions



The front passenger airbag warning label is located on the front and back of sun visor as shown in the figure above, and contains important information about front passenger airbag. Observe the following precautions:

- When using a rearward facing child restraint system in the front passenger seat, the passenger airbag must be OFF, Refer to "Enabling and Disabling Front Passenger Airbag".
- Never change the design of child restraint system fixing device or seat belt on the vehicle under any circumstances.
- Never fix child restraint system with seat belt only. Always use standard fixing device for child restraint system on the second row seat.

It is the driver's responsibility to comply to the instructions provided, and to the instructions provided by the CRS manufacturer.

WARNING

- Do not let children stand or sit in front of the front passenger seat.
- Front passenger position is equipped with front airbag. Do not use the rear-facing child restraint system in this seat.
- Failure to follow these above recommendations may endanger life or result in serious injury.
- NEVER use a rearward facing child restraint on a seat protected by an ACTIVE AIRBAG in front of it, DEATH or SERIOUS INJURY to the CHILD can occur.

Recommended Child Restraint Systems

- Child restraint system purchased by user in Asean countries should comply with UN R44/UN R129 standard.
- When using the child restraint system, please read the instructions of the child restraint system manufacturer carefully, install it in strict accordance with the installation method described in the instructions, and confirm that the child restraint system is installed firmly and stably.
- Remove head restraint if child restraint system interferes with the vehicle seat head restraint during installing the child restraint system.

The following table recommends the use of child restraint system for Asean countries:

2. PREPARATION FOR DRIVING

Weight group	Child weight	Manufacturer	Model	Installation Direction	Installation Method
Group 0	Up to 10 kg	Joie	Joie Spin 360	Rear-facing	ISOFIX with support leg
Group 0+	Up to 13 kg	Joie	Joie Spin 360	Rear-facing	ISOFIX with support leg
Group I	9 to 18 kg	Joie	Joie Spin 360	Rear-facing	ISOFIX with support leg
Group II	15 to 25 kg	Britax Römer	Britax Römer KidFix 2S/ 2R	Front-facing	ISOFIX and vehicle seat belt
Group III	22 to 36 kg	Britax Römer	Britax Römer KidFix 2S/ 2R	Front-facing	ISOFIX and vehicle seat belt

Note: When using Britax Römer KidFix 2S, extend the SICT side impact extension to be within 5mm of the door trim or until fully extended. Insert the vehicle lap belt into the bright red SecureGuard. Do not place the vehicle diagonal belt into the bright red SecureGuard.

Top Tether

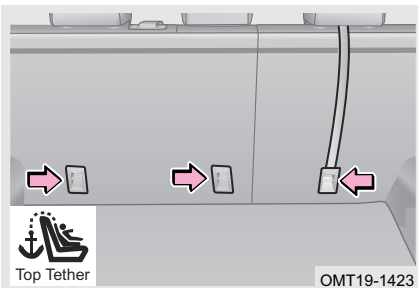

This model is equipped with top tether strap anchorages on the back of the rear seats.

Before using a top tether strap, remove the seating position head restraint and luggage compartment cover. With the child restraint on the seat, attach the top tether strap to the anchorage, and tighten to remove all slack. Refer to instructions provided by the CRS manufacturer.

READ

- Ensure all removed head restraints are stowed safely.
- After correct installation of the child restraint and top tether, the luggage compartment cover can be re-installed.

⚠ WARNING

Ensure the top tether strap anchor is attached correctly. Incorrect installation may cause serious injury to the child.

■ Rearward-facing child restraint system

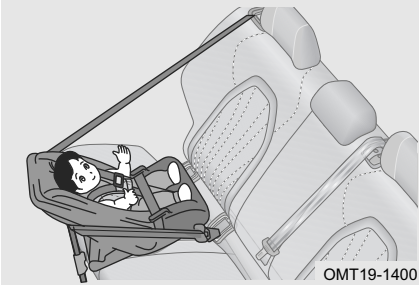

A rearward facing child restraint is installed to face to the rear of the vehicle. Only install a rearward facing child restraint on the front passenger seat if the airbag is OFF. It is recommended children use a rearward facing child restraint system up to 4yrs old.

■ Forward-facing child restraint system

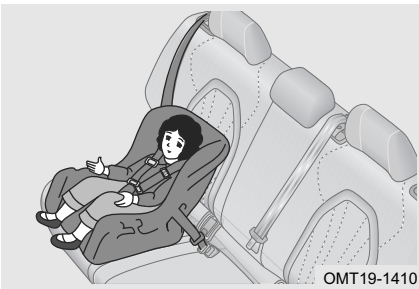

A forward facing child restraint is installed to face to the front of the vehicle. It is recommended children use a forward facing child restraint system when older than 4yrs old.

■ Booster seat child restraint system

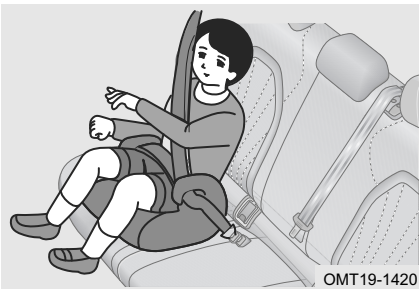

For larger children that cannot fit in a child restraint system with a high back, they may occupy a second row outboard seat using a booster seat, either attached to the lower anchorage points or belted, as described in the instructions provided by the child restraint system manufacturer.

2. PREPARATION FOR DRIVING

Installing Child Restraint Systems

Child Restraint Systems

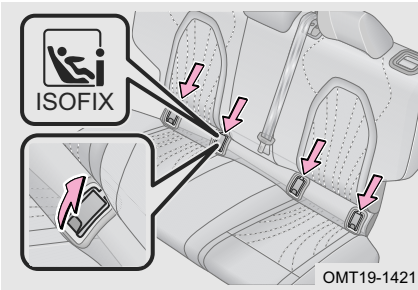

The rear outboard seats are equipped with ISOFIX / i-Size anchorages. The anchorage locations are identified by a marking (see illustration) located on the seat back, directly above the associated anchorages. Lift or remove the ISOFIX cover to access the anchorages.

■ Size class for child restraint systems (ISOFIX):

We recommend that children should use an appropriate child restraint system, and it is recommended that they are seated on a rear outboard seat.

Size Class	Fixing Device	Description
A	ISO/F3	Full-height, forward-facing child restraint systems
B	ISO/F2	Reduced-height forward-facing child restraint systems
B1	ISO/F2X	Reduced-height forward-facing child restraint systems
C	ISO/R3	Full-size, rearward-facing child restraint systems
D	ISO/R2	Reduced-size rearward-facing child restraint systems
E	ISO/R1	Rearward-facing infant seat
F	ISO/L1	Left lateral-facing (carrycot) infant seat
G	ISO/L2	Right lateral-facing (carrycot) infant seat

■ Table for locations of ISOFIX child seats:

Weight Groups	Size Class	Fixing Device	Front Passenger Seat	Second Row Outside Seat	Second Row Center Seat
Carrycot	F	ISO/L1	X	X	X
	G	ISO/L2	X	X	X
		(1)			
Group 0 (Up to 10 kg)	F	ISO/L1	X	X	X
	G	ISO/L2	X	X	X
	E	ISO/R1	X	IL	X
		(1)			
Group 0+ (Up to 13 kg)	E	ISO/R1	X	IL	X
	D	ISO/R2	X	IL	X
	C	ISO/R3	X	IL	X
		(1)			
Group I (9 to 18 kg)	D	ISO/R2	X	IL	X
	C	ISO/R3	X	IL	X
	B	ISO/F2	X	IL, IUF	X
	B1	ISO/F2X	X	IL, IUF	X
	A	ISO/F3	X	IL, IUF	X
		(1)			
Group II (15 to 25 kg)		(1)			
Group III (22 to 36 kg)		(1)			

- X: ISOFIX position is not suitable for the ISOFIX child restraint system of this weight group or this size classification.
- IL: It is suitable for the ISOFIX child restraint system of special class in the list. These restraint systems may be special vehicle class, restricted class or semi-universal class.
- IUF: It is suitable for the ISOFIX child restraint system of forward-facing universal class approved by this weight group.
- (1): Child restraint system without ISO/XX size identification (A to G). Please refer to the table of Recommended Child Restraint Systems.

2. PREPARATION FOR DRIVING

Installing Child Restraint Systems

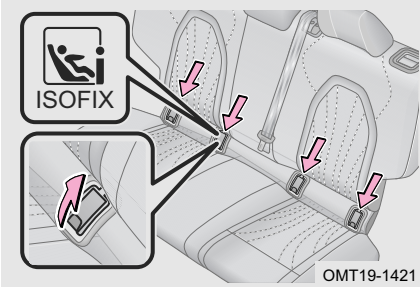

Step 1: Locate the ISOFIX anchorage;

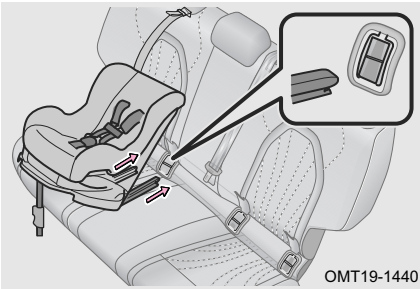

Step 2: Lift or remove the ISOFIX anchorage cover;

Step 3: Place the child restraint system on the rear outboard seat;

Step 4: Attach the child restraint ISOFIX probe to the anchorage. Where necessary extend the child restraint support leg.

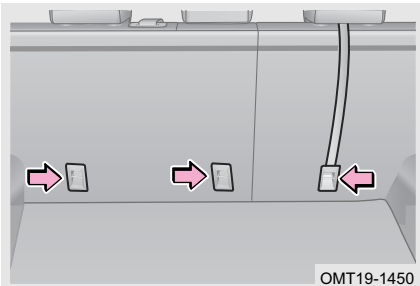

Step 5: Where a top tether strap is required, route, correctly attach and tighten the top tether strap to the top tether anchorage.

Note: If a luggage cover is present, it will need to be removed, to allow the upper tether access to the anchor point.

Note: Refer to the child restraint system instructions whether it needs to be secured by an upper tether belt.

READ

- If it interferes with the installation, the head restraint can be removed from the seat the child restraint system is installed on.
- After attaching the upper tether to the anchor point, be sure to tighten the tether and ensure it is secure. For the specific method of fixing and tightening upper tether of the child restraint system, strictly follow the instructions provided by the child restraint system manufacturer.
- Before installing the child restraint system that uses an upper tether, the head restraint must first be removed. This will limit or prevent interaction of the head restraint with the upper tether. In addition, any luggage cover present must first be removed.

 **WARNING**

- After installing a child restraint system, never adjust the seat.
- It is recommended child restraint systems are installed on the rear outboard seats.
- Never fix more than one child restraint system to one set of anchor points.
- Do not allow the upper tether to cross or pass the head restraint and be sure to tighten the tether after installing. Incorrect installation may cause serious injury to children.
- For the vehicle equipped with a luggage cover on the luggage compartment, the luggage cover must be removed before installing child restraint system to anchor points.
- If anchor point device is damaged or overloaded during an accident, please go to authorized service centre for inspection and repair immediately.
- If the driver's seat interferes with the correct installation of the child restraint system on the rear seat behind the driver seat, install the child restraint system on the rear seat behind the front passenger.
- Do not use child restraint system anchor bracket to secure items other than child restraint system. We will not be liable for any accident caused this way.
- If the child restraint system is not correctly fixed in place, the child or passengers may face serious injury or even death during a collision.
- Make sure the top tether is securely latched, and check if the child restraint system is secured by pushing and pulling it in different directions. Follow the installation instructions provided by the child restraint system manufacturer. If the child restraint system is not correctly installed, the child may face serious injury or even death during a collision.
- If the child restraint system on the rear seat interferes with the front seat, after all correct adjustments, do not install the child restraint system in that seat position; The child and front passenger may face serious injury or even death during a collision.
- Whether the child restraint system is in use or not in use, it should always be secure and fixed properly to the seat; Do not place unsecure child restraint systems on any passenger seats.

2. PREPARATION FOR DRIVING

Enabling and Disabling Front Passenger Airbag

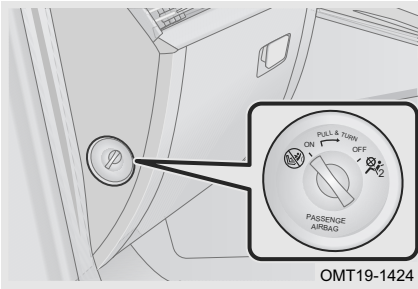

The airbag enabling/disabling switch is located on the passenger side instrument panel and is visible when front passenger door is opened.

■ Disabling front passenger airbag

Turn the switch to OFF position while pulling the switch outward, the front passenger airbag is disabled and the disabling status indicator will come on.

■ Enabling front passenger airbag

Turn the switch from OFF to ON, re-enable the front passenger airbag and the enabling status indicator will come on. It is now safe to sit in the front passenger seat.

Airbag status indicator

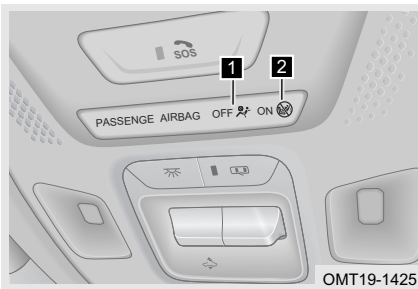

1 Disabling status indication

2 Enabling status indication

WARNING

- Remember to subsequently enable the front passenger airbag when an adult occupant is seated in the front passenger seat. It is the driver's responsibility to confirm the passenger airbag status is correct for the occupant in the front passenger seat.
- In the event a rearward facing child restraint system needs to be installed on the front passenger seat, the front passenger airbag must be disabled. Otherwise, it may face serious injury or even death to young children in the event of an accident.

Child Presence Detection in Rear Seat (If Equipped)

Introduction

Child Presence Detection function in rear seat is to identify if driver forgets the child in rear seat by mistake by judging the rear door switch sensor, and to remind driver through the emergency flashers. The vehicle activates a reminder when either of the following trigger conditions is met.

Warning trigger condition

- Before starting driving, any rear door has been opened. If any rear door is not opened again before stopping and locking the vehicle, warning signal will be sent.
- Before starting driving, rear doors on both sides have been opened. If only one side of the door is opened again before locking the vehicle, warning signal will be sent after locking the vehicle.

Note: Since the vehicle is judged by rear door switch sensor, the occurrence of false alarm cannot be ruled out.

Temporary system suspension

The system allows temporary suspension. IN the In-Car menu inside the vehicle Settings, there is a temporary off switch for this feature. Turn off the reminding function once through this switch when there is no need to remind temporarily. However, when the vehicle starts and drives next time, the switch will return to "ON" state by default.

3-1. Key Information	Audio Button..... 91
Key Information 69	Voice Recognition Function 91
Replacing Key Battery 70	Phone-link..... 92
Effective Range 72	
Keyless Entry 73	3-6. Air Conditioning System
Vehicle Security 74	Electric Air Conditioning 96
Immobilizer System 75	Automatic Air Conditioning 97
Remote Start 76	Mode Adjustment 101
3-2. Doors	Air Outlets Airflow Control 101
Doors Lock Switch..... 77	Interior Active Ventilation and Automatic Cleaning (If Equipped)..... 102
Unlocking Doors with Inside Handle 77	Air Quality Control System (If Equipped) 103
Door Mechanical Switch..... 78	Air Conditioning Cooling Operation..... 103
Rear Door Child Lock..... 79	Air Conditioning Heating Operation..... 105
3-3. Windows	Auxiliary Fascia Armrest Box Cooling / Warming Function (If Equipped)..... 105
Power Windows 80	
Window Remote Control Function 81	3-7. Wireless Charging
Window Jam Protection Function 82	Wireless Charging..... 105
3-4. Power Moon Roof	3-8. Assist Grips and Coat hooks
Power Moon Roof (If Equipped) 84	Assist Grips..... 107
Moon Roof Remote Control Function (If Equipped) 85	Coat hooks..... 107
Moon Roof Jam Protection Function (If Equipped) 86	3-9. Storage Space
3-5. Audio System	Storage Space..... 108
Audio View 87	3-10. Power Outlet
Audio Operation..... 88	Power Outlet 110
Audio Settings 88	USB Port 111

INTERIOR FUNCTION

3-11. Sun Visors and Vanity Mirrors	Power Boot Door..... 115
Sun Visors, Vanity Mirrors and TicketClips 112	Boot Door Emergency Opening..... 118
3-12. Bonnet	3-14. Fuel Tank Cover
Opening/closing the bonnet..... 113	Fuel Tank Cover..... 118
3-13. Boot Door	
Manual Boot Door 114	

3-1. Key Information

Key Information

Smart key

Smart key is used to lock/unlock doors remotely and open boot door within about 20 m (within clear view) of the vehicle.

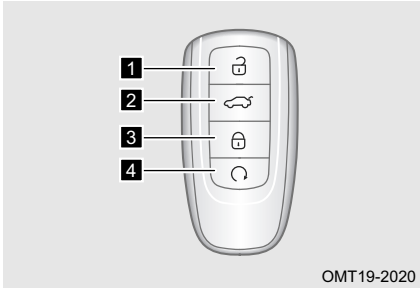

- 1** Unlock button
- 2** Boot door opener button
- 3** Lock button
- 4** Remote starting button

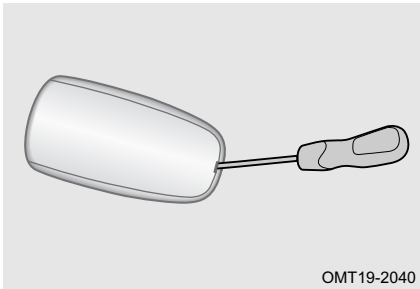

The mechanical key built into the smart key can be used to lock/unlock doors in emergency by prying off smart key cover using a flathead screwdriver with the tip taped and taking out mechanical key. After using, return it to original place for easy-to-carry (for details, refer to "Door").

3. INTERIOR FUNCTION

Function limit

- In the following conditions, the smart key may not work properly:
 - There exceed one smart keys being used nearby.
 - The distance between vehicle and smart key is over 20 m.
 - The smart key is in contact with, or is covered by a metallic object.
 - The smart key is placed near an electrical appliance (such as mobile phone, personal computer).
 - The key is near wireless communication devices that have the similar frequency with the remote control key (such as portable radio).
 - The key is near facilities that generate strong radio waves (such as TV tower, radio station, power station, airport, train station).

CAUTION

- This product is a low frequency radio device and can be disturbed by various radio services or radiation from industrial, scientific and medical applications.
- Do not change the transmitting frequency, increase the transmitter power (-including installation of the wireless RF power amplifier), or install an external or other transmitting antenna without permission.
- When using it, do not interfere with legal wireless communications; In case of interference, immediately stop using and take measures to eliminate the interference before continuing to use it.

■ If any of the following conditions occurs, the smart key battery may be low or depleted:

- The remote control distance gradually decreases.
- Remote control function does not work even without interference.
- Instrument cluster prompts "Smart key battery power is low".

Replacing Key Battery

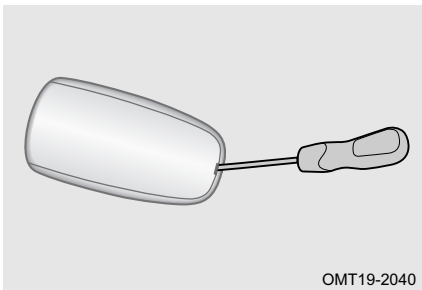

Step 1: Pry off smart key cover using a flathead screwdriver with the tip taped.

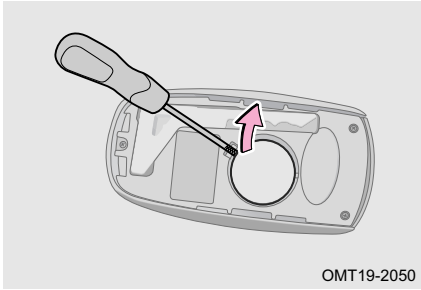

Step 2: Pry off battery cover using a flathead screwdriver with the tip taped, and remove the battery.

Step 3: Install new battery with the positive (+) side up.

Step 4: Install battery cover.

Step 5: Install smart key cover.

Step 6: After replacing the battery, check if the smart key operates properly. If the smart key still does not function correctly, please contact authorized service centre for inspection and repair as soon as possible.

CAUTION

- Only use the recommended battery type.
- Do not bend electrode and terminal when installing battery.
- Make sure your hands are dry and away from water when replacing the battery.
- Do not touch new battery with oily hands. Failure to do so may cause battery corrosion.
- Do not touch or move any components inside the smart key, or its functions may not work properly.
- There may be some difficulties when replacing key battery, that might lead to damage if you are replacing it by yourself, so it is recommended that you replace it at authorized service centre.

WARNING

- Do not swallow the battery. Doing so may cause chemical burns.
- A coin battery or button battery is used in the smart key. If a battery is swallowed, it may cause severe chemical burns in as little as 2 hours and may result in death or serious injury.
- Keep away new and removed batteries from children.
- If you accidentally swallow a battery or put a battery into a part of your body, get emergency medical attention immediately.

ENVIRONMENTAL PROTECTION

Used lithium battery cannot be handled as general household rubbish, please handle used battery according to the local regulations and provisions regarding environmental protection.

3. INTERIOR FUNCTION

READ

- Make sure that positive and negative terminals of battery are placed correctly.
- Smart key battery model: 3V-CR2032 lithium battery.

Effective Range

Detectable area

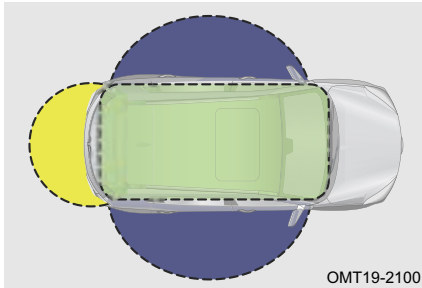

 Starting or switching power area

Start or switch power mode when smart key is the vehicle.

 Unlocking/locking area

Unlock/lock the doors when smart key is within effective range of door high performance low-frequency antenna.

 Opening boot door area

Open the boot door when smart key is within effective range of luggage compartment outer low-frequency antenna.

READ

Low-frequency antenna can detect areas within 1.5 m away from smart key. Therefore, when using keyless entry or ENGINE START STOP function, ensure that distance between the smart key and low-frequency antenna meets the requirement.

Function limit

- Smart key may be not detected in the following conditions:
 - Smart key is in luggage compartment.
 - When locking doors, smart key is too close to the window or roof.
 - Check if the smart key is placed together with strong electromagnetic interference sources (such as: portable power source, interphone or other phones etc.).

Keyless Entry

Unlocking doors

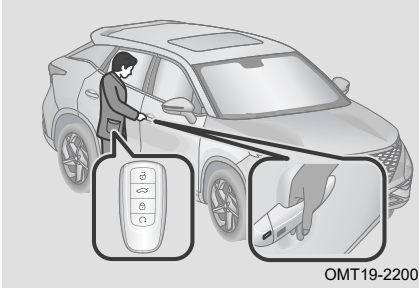

Touch the unlock sensing area with four fingers when carrying smart key on your person, the system automatically recognizes smart key and doors automatically unlock.

Locking doors

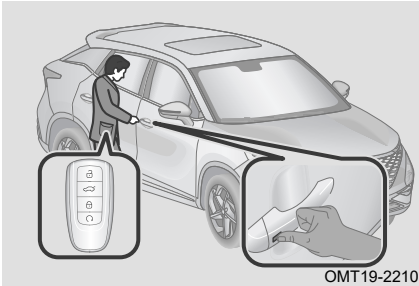

Touch the lock sensing area with fingers when carrying smart key on your person, the system automatically recognizes smart key and doors automatically lock.

⚠ CAUTION

- Do not put smart key next to computer, cordless mouse, phone, etc. doing so may not affect the lock/unlock sensor.
- After leaving the vehicle and closing all doors and boot door, smart key is left in vehicle or there is no smart key around vehicle within approximately 2.5 m, smart key sensing active lock function will not be activated.
- If the smart key is over 2.5 m away, the indicator signal lights do not flash and the horn is not hear (signals successful arming), check if the vehicle is locked.

3. INTERIOR FUNCTION

Vehicle Security

Arming operation

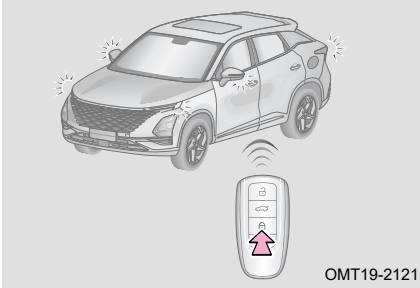

■ Arming mode

Turn vehicle power supply to OFF mode, bonnet, four doors and boot door are closed, perform locking operation of door (For details, refer to "Smart Key" in this section), and become armed.

Successful arming prompt: Hazard light flashes once and anti-theft horn sounds once.

Unsuccessful arming prompt: Hazard light flashes twice and anti-theft horn does not sound.

■ Secondary arming mode

After disarming, if four doors and boot door are not operated, the vehicle will lock automatically and become armed after 30 s.

READ

- Arming prompt is set in audio system. For details, refer to "Audio System".
- After disarming, if any of the four doors and boot door is opened, the vehicle will exit secondary arming mode.

CAUTION

- Vehicle arming cannot be set if vehicle power is not switched to OFF mode.
- If four doors are closed and boot door is not closed completely, the central lock will lock once but vehicle arming is not set successfully.
- If boot door is closed and any door is not closed, the central lock will lock and then unlock and vehicle arming is not set successfully.

Disarming mode



Perform unlocking operation of door to exit arming mode.

Successful disarming prompt:
Hazard light flashes twice.

Alarm mode

When the vehicle is armed and invalid entry is detected (such as any door, bonnet or boot door is opened invalidly, alarm will be activated), the vehicle will enter cyclic alarm mode, anti-theft horn sounds and indicator signal light flashes; Press unlock button on smart key or switch vehicle power to ON mode to disarm.

Immobilizer System

Engine immobilizer system

Smart key has a built-in transponder chip. If the smart key is not pre-matched into engine anti-theft module, the built-in chip will stop engine from starting. In the following conditions, the engine immobilizer system may not work properly:

- Smart key is in contact with a metallic object.
- Do not modify or remove engine immobilizer system.
- Smart key is too close to or contacts smart key (key with a built-in transponder chip) of another vehicle.

CAUTION

- Do not match the smart key by yourself, otherwise the engine immobilizer system may not work properly.
- If the engine fails to start, but the starter works normally, it may be due to the interference of engine immobilizer system, please contact authorized service centre immediately for inspection and repair immediately.

Vehicle anti-theft system

When vehicle is armed and invalid entry is detected, the vehicle anti-theft system will send sound-light alarm, alerting owner that the vehicle is in an invalid opening state.

3. INTERIOR FUNCTION

READ

- The vehicle anti-theft system will not be enabled if the doors are locked by mechanical key. It is recommended to lock doors by smart key.
- After locking doors by smart key, the vehicle anti-theft system will be triggered if front right door is unlocked and opened by mechanical key.
- To prevent unexpected triggering of vehicle anti-theft system and vehicle theft, before leaving the vehicle, check that nobody is in vehicle, all doors and windows are closed properly and the vehicle is armed correctly.
- When vehicle anti-theft system is in anti-theft state, vehicle anti-theft system can be disarmed by pressing unlock button on smart key or if the vehicle starts successfully.

Remote Start

When vehicle power mode is OFF, vehicle is locked and smart key is not in vehicle, press and hold lock button or remote starting button on smart key for several seconds to start it remotely and air conditioning operates automatically at the same time; The vehicle will automatically shut off after vehicle is started remotely for 10 minutes.

READ

- Ensure there is no one in the vehicle (including the driver) when starting the vehicle remotely.
- The vehicle can be unlocked but can not be locked by using remote start.
- Distance when starting vehicle remotely using smart key should not exceed normal operating distance of smart key.
- When single time for starting vehicle remotely is 10 minutes, allow vehicle to start remotely twice, if the two starting has been used, after vehicle power is turned to ON mode, remote start can be used.
- After vehicle is started remotely, some function cannot be operated (such as headlight stalk switch, wiper stalk switch, audio function), depress brake pedal when carrying smart key on your person, quit remote mode to restore normal operation.

3-2. Doors

Doors Lock Switch

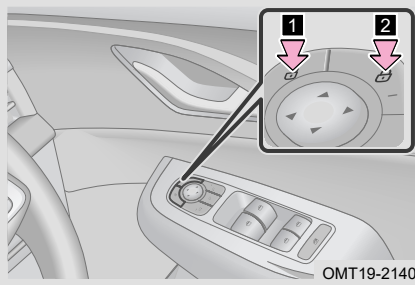

In the vehicle, press lock/unlock switch to lock/unlock the doors.

- 1** Unlock switch
- 2** Lock switch

 READ

When four doors are closed and vehicle speed is more than 9 mph (15 km/h), the door will automatically lock; Door automatic lock need to be set in audio system. For details, refer to "Audio System".

Unlocking Doors with Inside Handle

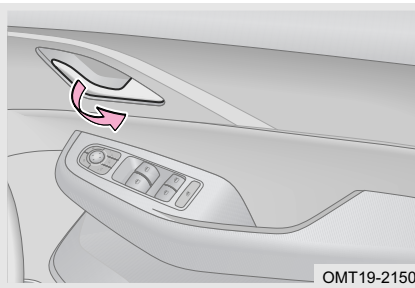

When doors are unlocked, pull door inside handle simply to open door. When doors are locked, pull door inside handle for the first time to unlock the door, and pull it again to open the door.

3. INTERIOR FUNCTION

Door Mechanical Switch

Vehicle can not be locked/unlocked electrically when battery is depleted , so in this case, the doors can be unlocked/locked with door mechanical switch.

Locking/unlocking front right door manually

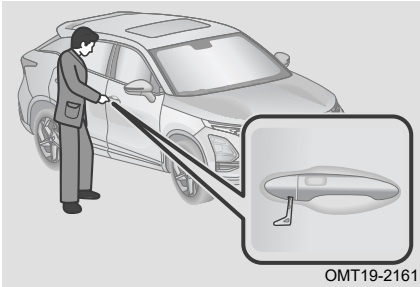

Step 1: Insert mechanical key into hole under front right door handle cover. Turn the key upwards to pry off the cover.

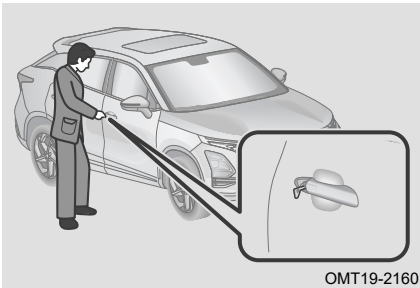

Step 2: Insert the mechanical key into the front right door key hole, turn clockwise to unlock the door, counterclockwise to lock the door.

Locking front left door/rear doors manually

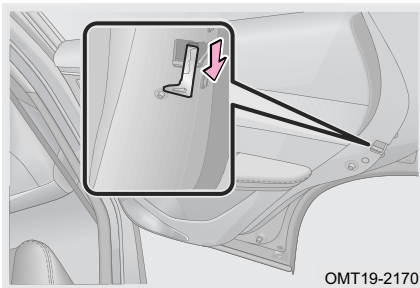

Step 1: Open the door.

Step 2: Insert the mechanical key or similar into mechanical switch hole from the door panel edge lock body.

Step 3: Press down the lock knob with mechanical key.

Step 4: Close the door. Pull the door handle to make sure the door is locked.

READ

- If the doors can not be unlocked/locked electrically, please contact authorized service centre for inspection and repair as soon as possible.
- When using door mechanical switch, please check if the doors are locked successfully one by one after locking. If unsuccessful, please contact authorized service centre as soon as possible.

Rear Door Child Lock

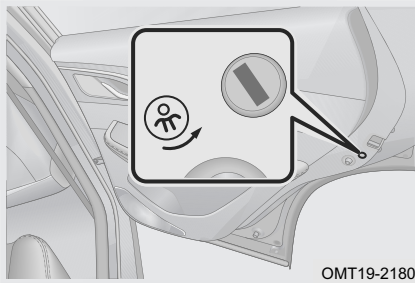

Lock: Turn the mechanical key or similar in the direction of arrow to activate the child lock, this means rear door can not be opened from inside and it only can be opened from outside.

Unlock: Turn the mechanical key or similar in the opposite direction of arrow to unlock the child lock so that the rear door can be opened from both inside and outside of vehicle.

⚠ WARNING

- The system is independent and can not replace the central lock mechanism in any case.
- Make sure that all doors are closed before driving, otherwise accidents and personal injury may occur.
- When a child is seated in vehicle rear seat, always activate the child lock to prevent rear door being opened accidentally while driving.
- In the case of an accident, when the child lock is activated and there is someone in vehicle, remember that, rear door can only be opened from outside.
- In hot weather, if vehicle stalls and all doors and windows close, do not allow any animal or child in vehicle alone. Otherwise, even if it is a short time, it may cause serious injury or even death due to sharp temperature rise.

3. INTERIOR FUNCTION

3-3. Windows

Power Windows

Power window switch

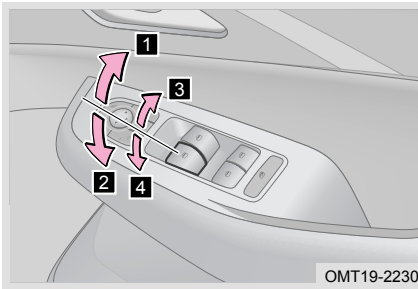

Operate power window switch after vehicle power is switched to ON mode:

- 1** Pull the switch to top, window will go up automatically; Press the switch again, window will stop moving.
- 2** Press the switch to bottom, window will go down automatically; Press the switch again, window will stop moving.
- 3** Pull the switch upwards by one level, window will go up; Release the switch, window will stop moving.
- 4** Press the switch downwards by one level, window will go down; Release the switch, window will stop moving.

READ

- Only vehicles with window jam protection function have one-touch window raising function.
- At the moment of starting engine, window up and down operation will be suspended to provide large current for engine starting.
- If the front door is not opened within 1 minutes while vehicle power is switched to OFF mode, the power window can be used.
- After leaving vehicle in low temperature environment for prolonged periods of time, when operating power window switch, window glass cannot be fully opened or closed. In this case, release the switch and then operate again, repeat 3-5 cycles to recover.

⚠ WARNING

- To avoid personal injury, it is driver's responsibility to guide all passengers to operate power window up/down switch and prevent children using, meanwhile, it is recommended to ensure that vehicle power has been switched to OFF mode or non-mechanical device is closed when leaving the vehicle.
- Take extra care to close windows, failure to do so may cause serious injury! Models without window jam protection function, when window glass rises, passenger's body may be caught, resulting in serious injury. Models with window jam protection function, jam protection function can be activated in jam protection area to protect passenger. However, for the thin or soft objects, jam protection function may be not activated, resulting in serious injury.

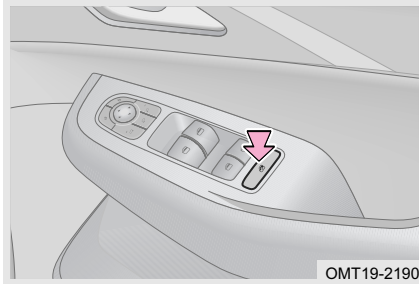
Passenger side window OFF switch

Press passenger side window OFF switch, passenger side window OFF switch indicator comes on, passenger side window switch will be disabled. After disabling, only window switches on driver side can be used to operate passenger side windows (this function is recommended when there is a child in vehicle). Press the switch again to cancel this function and the indicator goes off.

Window Remote Control Function**Window remote control window down function**

While vehicle power is switched to OFF mode, four doors are closed and unlock button on key is pressed and hold, windows of four doors will go down automatically. If unlock button on key is released or any door is opened in this process, window will stop going down.

Remote control one-touch window up function

While vehicle power is switched to OFF mode and the bonnet, four doors and boot door are closed, press lock button on smart key or touch the lock sensing area with fingers while carrying smart key on your person, the vehicle will be armed and the window glass of four doors will rise up automatically.

3. INTERIOR FUNCTION

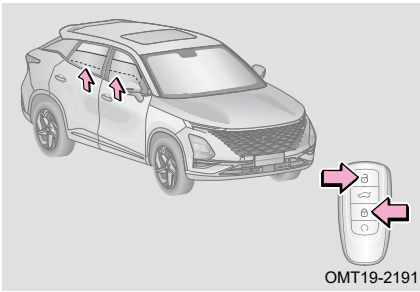

While the window is rising, press the lock/unlock button again, window glass stops rising. After pressing unlock button, glass stops rising, if four doors and boot door are not operated, the vehicle will lock automatically and become armed after 30 seconds.

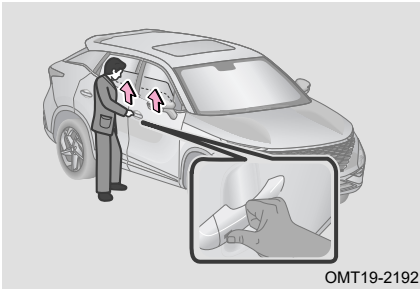

While the window is rising, touch lock sensing area with fingers (- carry smart key on your person), window glass stops rising.

After touching unlock sensing area with four fingers (carry smart key on your person), glass stops rising, if four doors and boot door are not operated, the vehicle will lock automatically and become armed after 30 seconds.

READ

If abnormal closing occurs during remote control one-touch window up, the indicator signal lights will flash once and the horn will sound 5 times continuously in order to alarm customer that window has not closed properly.

WARNING

Before using remote control up window function, take extra care to see the vehicle clearly and make sure that passengers cannot be caught by window.

Window Jam Protection Function

Jam protection function

During one-touch window up or remote control one-touch window up, if obstacle is encountered in jam protection area and resistance exceeds a certain value, window will stop rising and go down slightly; To close window, move away obstacle and operate again.

Canceling jam protection function

If obstacle is encountered twice continuously when rising the window, the window will stop rising, jam protection function will be canceled. Make sure there are no obstacles when the window is closed.

Perform the following steps to temporarily deactivate the jam protection function (for example, windows are difficult to close due to frost or similar reasons):

- Close the window twice in a row until the window encounters resistance and automatically retracts.
- Jam protection function will be invalid when the window is closed for the third time, and the window will overcome the resistance and be completely closed.
- If the window still cannot be closed after three attempts, please contact authorized service centre for inspection.

Overheat protection function

If the window is repeatedly opened or closed within a short period of time, the window operation will be stopped for a period of time.

Do not operate the power window switch continuously for more than 30 seconds, otherwise the corresponding window control switch will be temporarily disabled to protect the motor from overheating and burning. If the above situation occurs, release the switch for 15 seconds and then it returns to normal.

Manual learning function

If one-touch window up function and jam protection function can not operate, perform the following steps to restore function. Make sure that there are no obstacles within window range during learning.

Step 1: Switch vehicle power to ON mode;

Step 2: Operate window switch manually to fully close window, and hold it there for 2 s , then release the switch;

Step 3: Operate window switch manually to fully open window, and hold it there for 2 s , then release the switch.;

Step 4: Operate window switch manually to fully close window, then try to operate auto window up function;

Step 5: If window cannot close automatically, please repeat the above steps to set.

If window position memory setting is lost, it can also be set with remote control one-touch window up function. At this time, window will go down to bottom, then go up to top. Window can be closed normally and setting is successful.

3. INTERIOR FUNCTION

READ

- If auto window up function cannot be restored after repeating the above steps, please go to authorized service centre for inspection and repair as soon as possible.
- When driving over roads with potholes or uneven surfaces, this may affect door system unexpectedly. In this case, window may reverse and go down while rising by one-touch window up function. This is a low probability event and normal.

CAUTION

- If disconnecting battery cable and then reconnecting it, auto window up function and jam protection function will not work.
- Jam protection function is a kind of window safety protection function. Never try to active it repeatedly using various objects, in improper methods or even with some parts of body. Falling to do so may damage window regulation system mechanism or injure personal accidentally.
- When closing window, even if it is equipped with jam protection function, always keep window close area is clear. Otherwise, if system encounters a thin object and cannot sense it, jam protection will not work. If someone's hand or finger is caught, extremely serious injury will be caused.

3-4. Power Moon Roof

Power Moon Roof (If Equipped)

Introduction

Use the overhead switch to open and close the moon roof and tilt it up and down.

Usage method

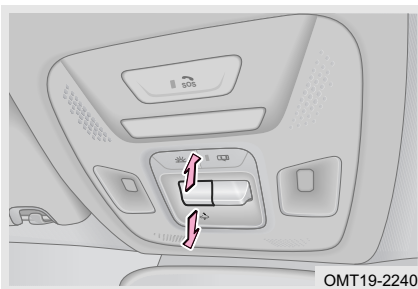

■ Tilting up/closing moon roof

Push "  " switch backward when moon roof is closed, the moon roof will tilt up.

Push "  " switch forward when moon roof tilts up, the moon roof will close.

■ Opening/closing moon roof

Push "↔" switch backward when moon roof is closed, the moon roof will tilt up, push the switch backward again, the moon roof will slide to open.

Push "↔" switch forward when moon roof is opened, the moon roof will slide to close.

CAUTION

- If the moon roof jam protection function fails, initial memory position may be lost, and it will be necessary to recalibrate position.
- If there is no response from moon roof during voice control or local button operation, it needs to be re-initialized.
- When moon roof is frozen or covered with snow, forcibly opening moon roof will damage the moon roof glass and the motor.
- If there is water on moon roof after raining, to prevent water from flowing into the vehicle when opening moon roof, always wipe off water or tilt moon roof up to remove these water before opening it.
- Regularly clean the dust and debris in moon roof rails and strips with water; After vehicle washing or raining, completely wipe the water on the moon roof glass before using.
- If you find there is a false jam protection, please go to authorized service centre for inspection and repair as soon as possible.
- The sun visor cannot be closed when the moon roof glass is opening; The moon roof mechanism will be damaged if the sun visor is forcibly closed.

WARNING

Before closing moon roof, take extra care to see the vehicle clearly and make sure that passengers cannot be caught by it.

Method of initializing moon roof (if equipped)

When moon roof is closed fully, push "↔" switch forward for more than 10 s.

CAUTION

If moon roof cannot be initialized, please go to authorized service centre to perform it by after-sales personnel.

Moon Roof Remote Control Function (If Equipped)

Moon roof remote control open function

While vehicle power is switched to OFF mode, four doors are closed and unlock button on smart key is pressed and hold for a few seconds, sunshade is opened and then moon roof is opened; Press the lock button or touch the lock sensing area while carrying smart key on your person during opening moon roof, moon roof stops moving.

3. INTERIOR FUNCTION

Moon roof remote control close function

While vehicle power is switched to OFF mode, four doors are closed and unlock button on smart key is pressed, the vehicle will be armed and moon roof is closed; Press the lock button or touch the lock sensing area with fingers when carrying smart key on your person during closing moon roof, moon roof stops moving.

Moon Roof Jam Protection Function (If Equipped)

Jam protection function

During moon roof glass is closed, it will automatically return under certain resistance. When jam protection occurs in horizontal position, the moon roof glass will return to half open position. When jam protection occurs in vertical position, it will return to tilt up position.

 WARNING
--

Do not pass body parts or objects through moon roof during opening and closing, even if it is equipped with jam protection function.
--

Overheat protection function

Do not operate the moon roof frequently in a short time, otherwise the motor will overheat or enter the overheat protection state. After that, the moon roof will not respond to key action. The overheat protection will be automatically canceled after the motor is cooled.

3-5. Audio System

Audio View

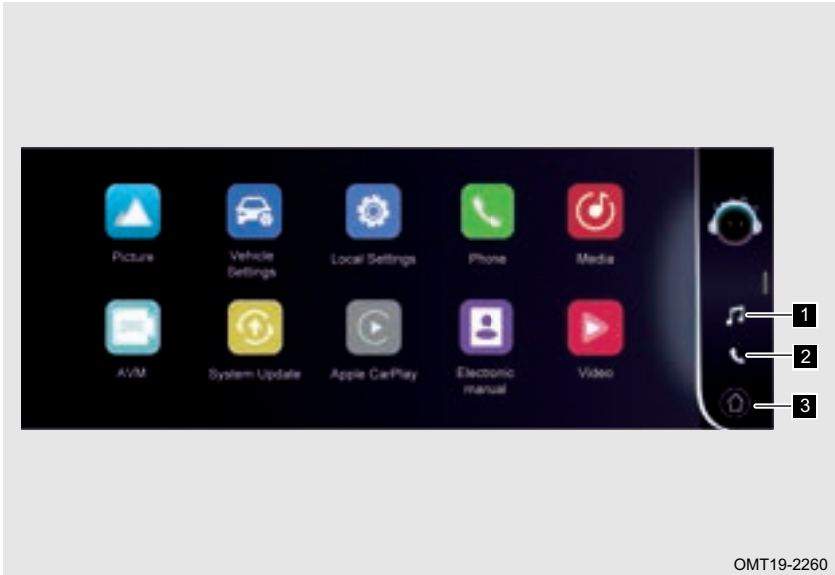

1 Media button

Click to enter media screen, including radio/DAB radio, music, images and video.

2 Answer button

Click to answer the call or enter phone screen.

3 Main screen button

Click to enter audio main screen.

Note: Function buttons are different according to the vehicle configuration. Please refer to the actual vehicle configuration.

Audio system control button

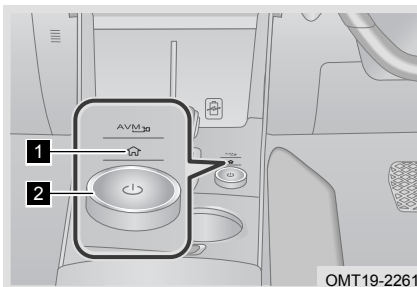

1 Enter the main screen of audio system.

2 Press the switch to turn on/off audio system; turn it clockwise to increase the volume, turn it counterclockwise to reduce the volume.

OMT19-2261

3. INTERIOR FUNCTION

Audio Operation

Audio main screen



Click the main screen button on main menu or audio control panel to enter the audio main screen.

Electronic manual

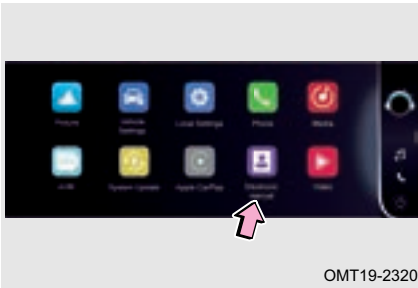

Click electronic manual application on audio main screen to check the detailed operating instructions of the audio system.

Audio Settings

Local Settings

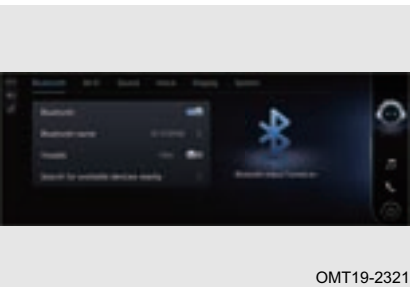

Bluetooth, wifi, sound, voice, display and system setting can be set on local settings screen.

Vehicle Settings

■ Lighting settings

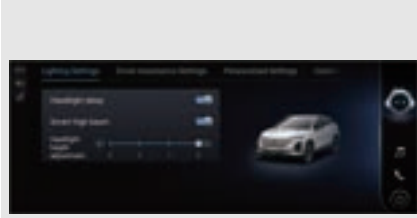

OMT19-2323

Daytime running lights: ON / OFF.

Headlight delay: ON / OFF.

Intelligent high beam: ON / OFF.

Headlight height adjustment: Level 0 to 3.

■ Driver assistance settings



OMT19-2324

Blind spot detection: ON / OFF.

Front bump warning: ON / OFF.

FCW sensitivity adjustment: Close, Far, Standard or Near.

Automatic emergency braking: ON / OFF.

Lane departure warning: ON / OFF.

Lane departure warning mode: vibration only, sound only, sound+vibration.

Lane departure sensitivity: low sensitivity, high sensitivity.

Speed limit assist: ON / OFF.

Overspeeding alarm: ON / OFF, and set speed limit value within 20 mph - 800 mph.

Driver monitor reminder: ON / OFF.

Rear cross traffic braking system: ON / OFF.

Emergency lane keeping: ON / OFF.

Lane departure prevention: ON / OFF.

Intelligent speed control: ON / OFF.

Intelligent accident avoidance: ON / OFF.

Pilot system exit reminder: ON / OFF.

Drive away reminder: ON / OFF.

Steering force mode: Comfort / Sport.

Steering force mode linking to driving mode: ON / OFF.

Driving mode memory: ON / OFF.

3. INTERIOR FUNCTION

■ Personalized settings

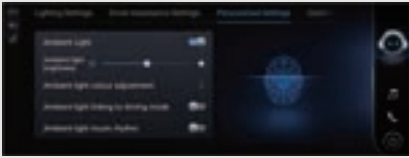

OMT19-2325

Ambient light: ON / OFF.

Ambient light brightness: Set brightness of ambient light.

Ambient light colour adjustment: Set color of ambient light.

Ambient light linking to driving mode: ON / OFF.

Ambient light music rhythm: ON / OFF.

■ Controls



OMT19-2326

Automatic locking: ON / OFF.

Lock reminder: Light + Horn / Light.

Automatic folding of exterior mirrors: ON / OFF.

Opening height setting of rear door: Set opening height of boot door.

Wireless charging settings: ON / OFF.

Phone reminder: ON / OFF.

■ Air conditioning settings

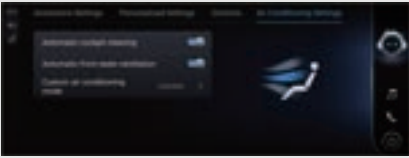

OMT19-2327

Automatic cockpit cleaning: ON / OFF.

Automatic cockpit ventilation: ON / OFF.

Custom air conditioning mode: Set to Energy-saving / Comfort / Strong.

READ

The setting items are different according to the configuration of the vehicle. Please refer to the actual vehicle settings.

Audio Button

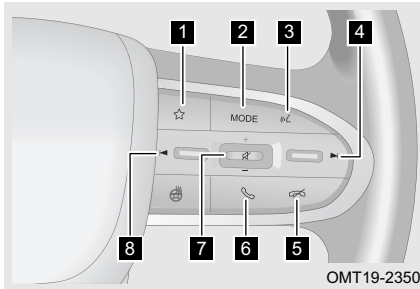

1 Quick button

Set the custom key function of steering wheel on local settings screen.

2 Mode switch button

Switch the mode: radio - USB music - bluetooth music - local storage music - radio.

3 Voice recognition button

Short press to enable the local voice recognition function; Long press to enable the Siri function or CarLife voice function (need to be connected with phone).

4 Switch to the next radio station or music.

5 Hang up the call.

6 Answer the call or enter Bluetooth screen.

7 Dial up to increase the volume; dial down to decrease the volume; press to mute/unmute or pause/resume the current operation.

8 Switch to the previous radio station or music.

READ

The settings are different according to the buttons of vehicle. Please refer to the actual vehicle.

Voice Recognition Function

Voice recognition function can be enabled using the following methods when audio system is turned on:

Method 1: Directly say the wake word to enable the voice recognition function.

Method 2: Short press the voice recognition button "☎" on steering wheel to enable the voice recognition function.

3. INTERIOR FUNCTION

Phone-link

Apple CarPlay (iOS)

■ Connecting method

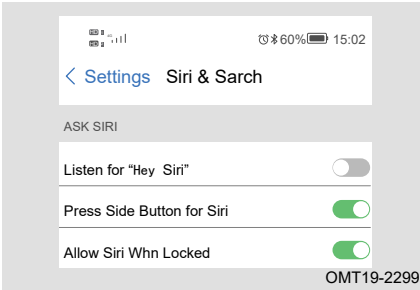

Step 1: Turn Listen for "Hey Siri" and Press Side Button for Siri to ON on Settings (Siri&search) screen of phone;

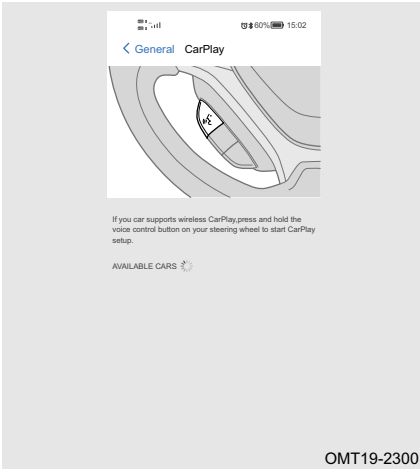

Step 2: Turn CarPlay to ON on Settings (General) screen of phone;

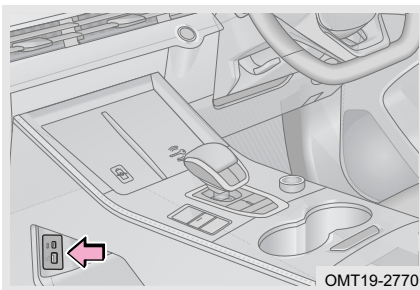

Step 3: Connect USB port and phone using original data cable;

Note: Only USB port " " supports Apple CarPlay screencast function.

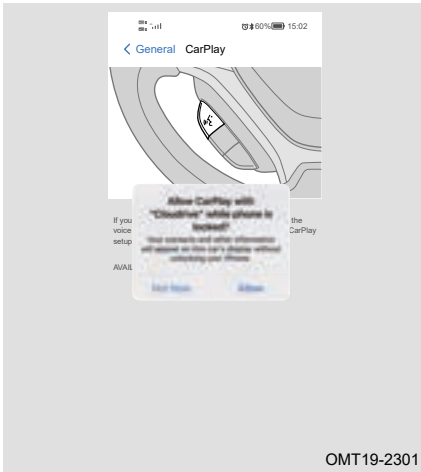

Step 4: Select Allow on CarPlay permission request screen;

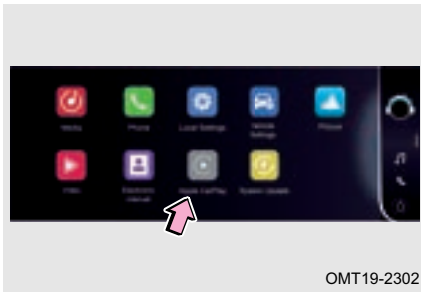

Step 5: Enter Apple CarPlay screencast screen.

■ Wireless carplay connection

Step 1: Turn on hotspot on Apple phone, audio head unit WIFI interface is connected to phone hotspot.

Step 2: Connect Apple phone to Bluetooth on audio head unit.

Step 3: Select Carplay according to interface that pops up on audio head unit or phone.

Step 4: Make pairing connection according to pop-up interface on phone; after connection is successfully, audio head unit displays carplay interface.

Step 5: Enter Apple CarPlay screencast screen.

3. INTERIOR FUNCTION

Android Auto (Android)

■ Connecting method

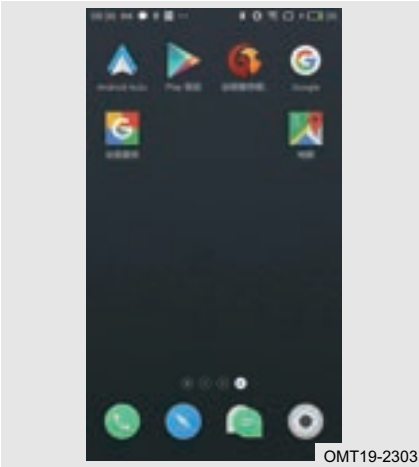

Step 1: Install the Google Framework;

Step 2: Perform the installation in Google Play and run Android Auto, install all supporting softwares according to the system prompt and update the existing program, and then Android Auto can run normal after completing the update.

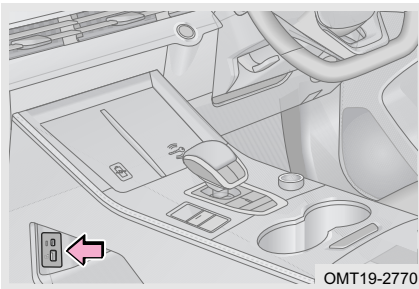

Step 3: Connect USB port and phone using original data cable;

Note: Only USB port "  " supports Android Auto screencast function. Before phone-link, please turn on the developer permissions in the phone settings.

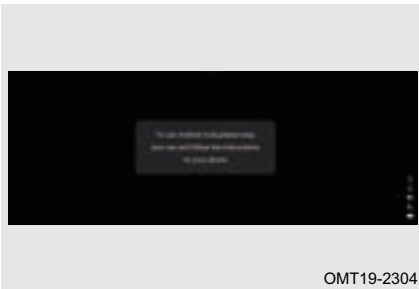

Step 4: If this phone is connected to the vehicle for the first time (a prompt will pop up on the head unit, please operate according to the prompt on the mobile phone, stop the vehicle and apply the parking brake), then the first connection setting can be completed;



Step 5: Click "Android Auto" on the audio main screen to enter "Android Auto" mapping interface.

■ Wireless Android Auto connection

Step 1: Turn on wireless Android Auto switch on the phone.

Step 2: Turn on Wi-Fi hotspot on head unit.

Step 3: Perform Bluetooth pairing between head unit and mobile phone.

Step 4: After Bluetooth connection is successful, a reminder to start wireless Android Auto will pop up on head unit, click "START" to complete wireless Android Auto connection.

3. INTERIOR FUNCTION

3-6. Air Conditioning System

Electric Air Conditioning

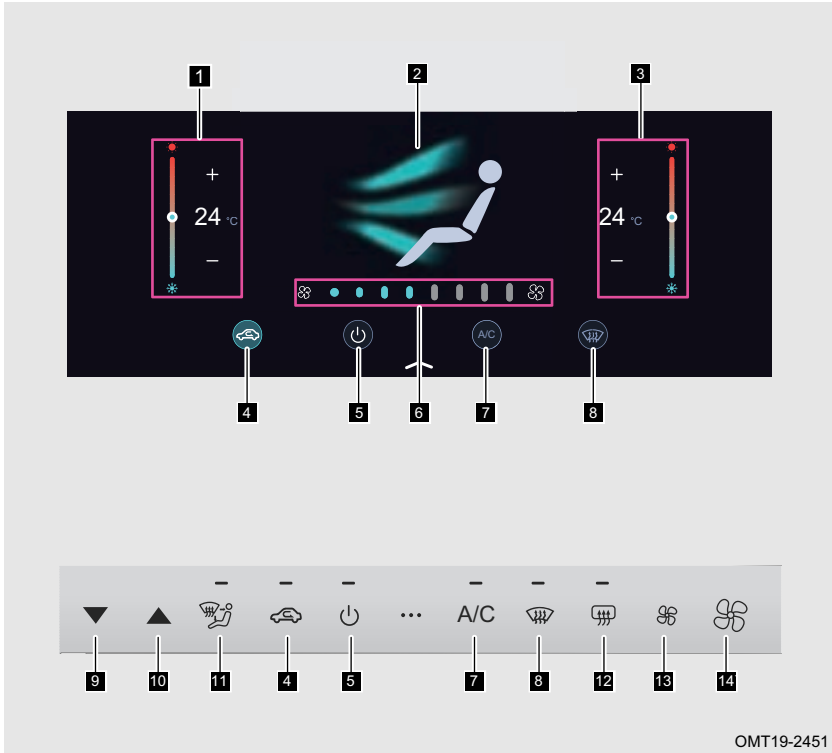

1 Front passenger side temperature adjustment area

2 Mode adjustment area

3 Driver side temperature adjustment area

4 Outside/recirculated air mode button

5 Power button

6 Fan speed adjustment area

7 A/C button

8 Front windshield defogging and defrosting button

9 Temperature decrease button

10 Temperature increase button

11 Mode adjustment button

12 Rear defrosting/ outside rear view mirror defrosting button

13 Fan speed decrease button

14 Fan speed increase button

Note: Function buttons are different depending on the vehicle configuration. Please refer to the actual vehicle configuration.

Automatic Air Conditioning

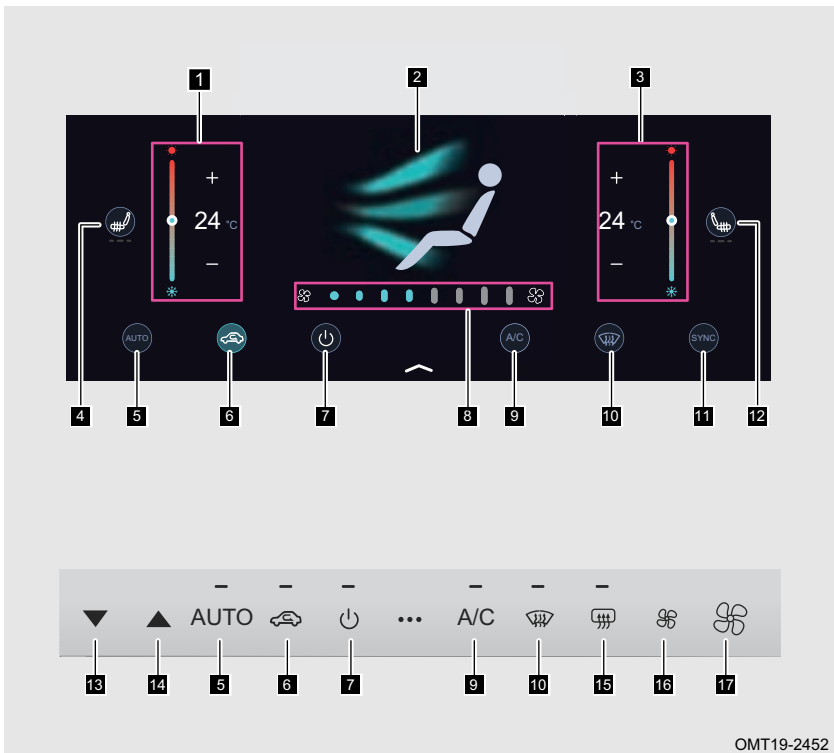

OMT19-2452

3. INTERIOR FUNCTION

1 Front passenger side temperature adjustment area

2 Mode adjustment area

3 Driver side temperature adjustment area

4 Front passenger seat heater button

5 AUTO button

6 Outside/recirculated air mode button

7 Power button

8 Fan speed adjustment area

9 A/C button

10 Front windshield defogging and defrosting button

11 SYNC button

12 Driver seat heater button

13 Temperature decrease button

14 Temperature increase button

15 Rear defrosting/ outside rear view mirror defrosting button

16 Fan speed decrease button

17 Fan speed increase button

Note: Function buttons are different according to the vehicle configuration. Please refer to the actual vehicle configuration.

READ

Do not leave the air conditioning system on longer than necessary when the engine is off to prevent the battery from being depleted.

Fan speed adjustment

The airflow volume can be adjusted by operating the fan speed adjustment buttons on air conditioning control panel or the soft button on display screen.

Outside/recirculated air mode button

The outside/recirculated air mode can be switched by operating the outside/recirculated air mode button.

Press outside/recirculated air mode button. If indicator comes on, it indicates that it is in recirculated air mode; if indicator goes off, it indicates that it is in outside air mode.

Use the recirculated air mode under following conditions:

- In dusty environment.
- Keep out smells from exterior.
- Prevent outside exhaust gas from entering vehicle.
- To quickly cool or heat the air in the vehicle.

A/C button

The air conditioning cooling can be achieved by operating the A/C button.

The A/C button indicator comes on, indicating that the air conditioning compressor is turned on. The indicator goes off, indicating that air conditioning compressor is turned off.

Power button

The air conditioning system can be turned on/off by operating power button.

Front windshield defogging and defrosting

The front windshield defogging and defrosting function can be achieved by operating front windshield defogging and defrosting button.

Front windshield defogging and defrosting button indicator comes on, indicating that the front windshield defog and defrost function starts to operate. The indicator goes off, indicating that the front windshield defogging and defrosting function stops operating.

Front windshield defogging and defrosting: Most of the airflow blows to front windshield, a small amount of airflow blows to side windshield.

When the air volume is not OFF, touching front windshield defogging and defrosting button will start the outside air mode and air conditioning compressor forcibly.

For the best defogging and defrosting effect, please operate as follows:

Step 1: Before driving, make sure that the inner surface of glass is clean and dry, if there is obvious dust or water drop, it is necessary to wipe off;

Step 2: Air volume adjustment: Max level;

Step 3: Temperature adjustment: Adjust comfortable temperature;

Step 4: Outside/recirculated air mode switching: Select outside air mode;

Step 5: Mode adjustment: Touch defrost button or adjust foot/defrosting mode;

Step 6: Turn on the cooling system: A/C indicator comes on.

READ

- When defogging in humid climate (such as rain and snow): Please keep A/C on. If A/C is off, it will affect defogging effect.
- When defogging in humid climate (such as rain and snow): Please keep outside air mode. If select recirculated air mode, it will affect defogging effect.
- When defogging in winter: Please keep outside air mode, adjust the direction of partial heat, the air outlets on both sides of the instrument panel face the windows on both sides, and when outside temperature is above 0°C, A/C auxiliary defogging is needed.
- If the A/C does not cool, it will affect the defogging effect, please contact authorized service centre for inspection and repair as soon as possible.
- After wiping off all frost or fog, to improve comfort in vehicle, adjust mode and air volume to correct position.

3. INTERIOR FUNCTION

CAUTION

- For driving safety, please use the defogging function correctly.
- Please do not use recirculated air mode for prolonged periods of time in winter, otherwise the front windshield will be fogged quickly.
- Poor visibility will increase the risk of traffic accidents and personal injury. Therefore, it is very important for traffic safety to ensure a good visibility during driving.

Rear defrosting/outside rear view mirror defrosting

After turning vehicle power to ON mode, press the rear defrosting button, the indicator comes on, indicating that the rear defrosting/outside rear view mirror defrosting function starts to work. The indicator goes off, indicating that the rear defrosting/ outside rear view mirror defrosting function stops working.

The function will automatically shut off after the defrosters have operated about 20 minutes.

CAUTION

- Please refer to your own particular vehicle for the heating function and rear defrosting function (if equipped) of outside rear view mirror.
- Make sure that the rear defroster is turned off when the fog and frost on window surfaces are cleared.
- Do not scratch or damage the heater wires when cleaning the rear windshield or outside rear view mirror.
- When the battery is low, the rear defroster cannot be turned on to allow the vehicle to start normally.

WARNING

To prevent burning yourself, do not touch the rear windshield or outside rear view mirror when the defroster is operating or has just turned off.

AUTO button

AUTO mode can be turned on by operating AUTO button.

In AUTO mode, with operating A/C switch, blowing mode, adjusting air volume or temperature LOW/HI, the corresponding function exits from AUTO mode.

In AUTO mode, outside/recirculated air mode switches and the circulation function exits the automatic control, and other functions are still in the AUTO mode.

In AUTO mode, operating the AUTO button will not exit from AUTO mode.

SYNC button

The mode switches between dual mode and single mode each time SYNC button is pressed.

Single mode: SYNC indicator comes on, indicating that the air conditioning is in single control mode. Driver side and front passenger side temperature cannot be adjusted separately.

Dual mode: SYNC indicator goes off, indicating that the air conditioning is in dual control mode. Driver side and front passenger side temperature can be adjusted separately.

Mode Adjustment

The mode adjustment can be achieved by operating the mode adjustment button (defrosting mode, face mode and foot mode can be combined) on air conditioning control panel or the soft button on display screen.

"  " Defrosting mode: Airflow is blown out from defroster outlet.

"  " Face mode: Airflow is blown out from center and face outlets on both sides.

"  " Foot mode: Airflow is blown out from foot outlet.

READ

- Face mode and defrosting mode cannot be combined.
- If windshield windows become fogged-up during driving, defrosting mode is recommended. For details, refer to Front Windshield Defog and Defrost in this section.

Air Outlets Airflow Control

Center outlets

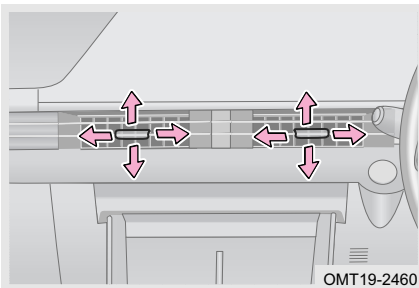

Move center outlet adjustment lever up, down, left or right by hand to adjust direction of airflow.

3. INTERIOR FUNCTION

Side outlets

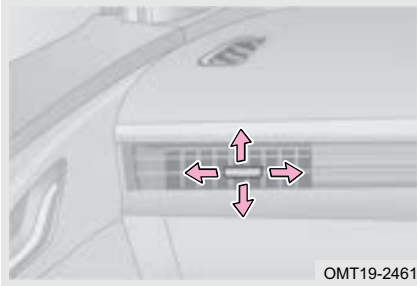

Move left/right side outlet adjustment lever up, down, left or right by hand to adjust direction of airflow.

Rear outlets

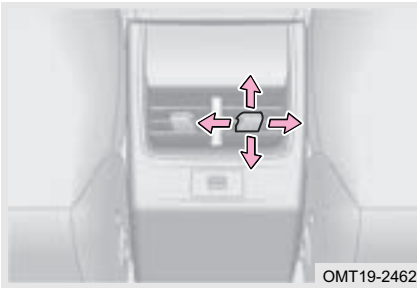

Move rear outlet adjustment lever up, down, left or right by hand to adjust direction of airflow.

Interior Active Ventilation and Automatic Cleaning (If Equipped)

Interior active ventilation

In hot weather, when the vehicle is parked outside, the temperature in the vehicle will be high. The interior active ventilation function can be set through the audio setting to cool the temperature in advance and remove the odor coming from the interior trim.

When the outside temperature is higher than 20°C and the system detects that the battery voltage meets the requirements, the vehicle will disarm and the blower will start working in advance (30 seconds).

When the working time of the blower exceeds 30 seconds, any door is opened or the vehicle is armed, the blower will stop working.

READ

The blower can operate up to two times before starting vehicle.

Interior automatic cleaning

The interior automatic cleaning function can be set through the audio setting used to dry the air conditioning pipeline to keep air conditioning system relatively dry and avoid the accumulation of a large number of bacteria and other dirt.

If the A/C was turned on during the last journey and the battery has enough power, the blower will work for 1 minute and then stop after the vehicle is armed for 5 minutes or more.

READ

Interior active ventilation and automatic cleaning are set in audio system. For details, refer to "Audio System".

Air Quality Control System (If Equipped)

When the outside air quality level is detected to decline in AUTO mode, the recirculated air mode will be turned on automatically. When the air quality returns to a proper level, the recirculated air mode will be turned off automatically. This function cannot be used to detect unpleasant gas. When the ambient temperature is ≤ 2 °C, air quality control system does not respond, to prevent windshield and window from fogging up.

Air Conditioning Cooling Operation

When the engine is working:

Click the AUTO button on display to set temperature, automatically control mode, air volume, outside/recirculated air mode, cooling system starts operating.

For your convenience and to improve the cooling effect of the air conditioner, click the AUTO button on display and set the A/C temperature to 22°C.

In the automatic mode, the corresponding function exits from automatic mode when operating A/C button, mode adjustment button, air speed adjustment or temperature LOW/HI, however, other functions are still in automatic mode .

3. INTERIOR FUNCTION

READ

- Surface dirt and block in A/C condenser surface may cause poor cooling effect, please keep condenser clean.
- When air is cooled down quickly in humid and warm conditions, fog may be seen coming from the outlet, this is normal.
- When the temperature is low, such as in winter, even if indicator comes on after operating A/C button, A/C compressor still cannot be started.
- Water dripping from the A/C drain pipe and forming a pool after use of A/C cooling system is normal.
- Refrigerant filled in A/C system will decrease over time, if you feel cooling effect of A/C is poor, please go to authorized service centre for inspection and repair in time.
- It is recommended to turn on A/C cooling system not less than 5 minutes every month and open the window simultaneously, this will help to prevent A/C system damage due to lack of lubricant, and also prevent evaporator odor due to moist and germs.
- If A/C is on and vehicle is continually climbing long slopes, or is in heavy slow moving traffic for a prolonged period, the engine may become overheated. Please observe the high coolant temperature warning light. If engine is overheating, it is advisable to turn off A/C.
- After temperature in vehicle is decreased to lower temperature, to reduce the influence to power system power and fuel consumption, compressor will turn off automatically, so if using A/C in spring and autumn seasons with low temperature, the compressor will be turned on or off automatically, this is normal.
- During sudden acceleration, overtaking and climbing, power system needs more power for compensation. At this time, if the A/C is operating, the compressor may be turned off automatically, if it does not turn off and you feel lack of power, it is recommended to turn off A/C.

WARNING

- To extend service life of A/C system, do not use the A/C for prolonged periods of time with low speed when using A/C cooling.
- It is forbidden to repair A/C system by yourself, since the high pressure refrigerant is harmful to human, it is necessary to go to authorized service centre for inspection and repair.
- Please purchase special refrigerant and compressor lubricant at authorized service centre, otherwise, A/C system damages sustained by this are not under warranty.
- In hot weather, the temperature in closed vehicle will quickly increase due to sunshine, this may cause personal or animal injury or death, especially for infants and very young children.

Air Conditioning Heating Operation

When the engine is working:

The A/C temperature can be adjusted by operating the temperature adjustment button on front row control panel or sliding temperature adjustment area on slide display; The A/C airflow volume can be adjusted by operating the vehicle air speed adjustment button on front/second row control panel or sliding airflow volume adjustment area on slide display. It is recommended to adjust mode to foot mode and turn off cooling system (A/C compressor is turned off).

Auxiliary Fascia Armrest Box Cooling / Warming Function (If Equipped)

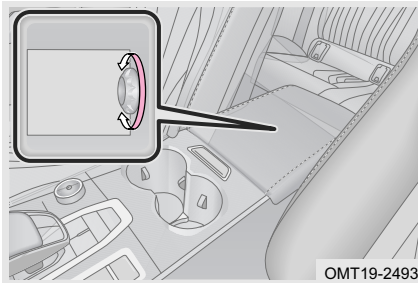

Place necessary items (For example: Canned drinks) in the auxiliary fascia armrest box to perform A/C cooling / warming operation. Rotate inner button of armrest box to cool / warm the necessary items.

WARNING

Those items can not be too big, otherwise, the auxiliary fascia armrest box can not be closed. Movement of driver's arm may be interfered if the auxiliary fascia armrest box is not closed. Be careful not to get hurt.

3-7. Wireless Charging

Wireless Charging

Introduction

Wireless charging uses electromagnetic induction technology, conveniently and safely to allow for a better better experience while driving.

3. INTERIOR FUNCTION

Usage method

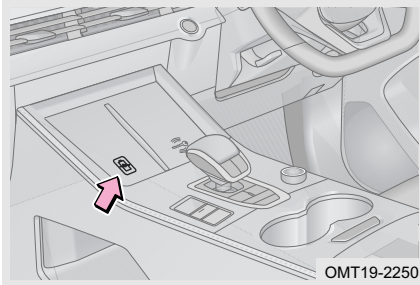

While vehicle power is switched to ON mode, the wireless charging starts to work after putting the mobile phone in wireless charging sensing area, and the audio head unit displays "📶". The audio head unit displays "🔋" after charging is completely.

- In the following conditions, the wireless charging may not work properly:
 - The mobile phone cannot be charged if the back of the phone is more than 8 mm away from wireless charging sensing area.
 - The mobile phone cannot be charged if the back of the phone has thick metal (such as coin, metal mobile phone shell), and audio head unit displays "🔋!".
 - When the surface temperature of wireless charging sensing area is higher than 65°C due to sun exposure, the wireless charging module will trigger self-protection and the mobile phone cannot be charged.

READ

- Wireless charging function is set in audio system (for details, refer to "- Audio System").
- Wireless charging function only supports mobile phones with wireless charging function.
- Please put the mobile phone in the center of the mobile phone slot. If you accelerate, decelerate or turn sharply during driving, the mobile phone will shake, which may affect the charging efficiency and stability.

CAUTION

- In order to ensure the connection between vehicle and smart key, there will be a temporary charging shield.
- If your mobile phone does not support the wireless charging function, it is recommended that do not use the wireless charging patch. The quality of the wireless charging patch in the market is uneven, and frequent use is easy to damage (such as function failure, interface poor contact, metal foreign object recognition failure, etc.).

Phone forgetting reminder function

While vehicle power is switched to OFF mode, open driver door and if your mobile phone is left in wireless charging sensing area, it will sound an alarm

for 20 seconds or take the phone out within 20 seconds, then the alarm will stop.

Note: Phone forgetting reminder function is set in audio system after wireless charging function is turned on.

3-8. Assist Grips and Coat hooks

Assist Grips

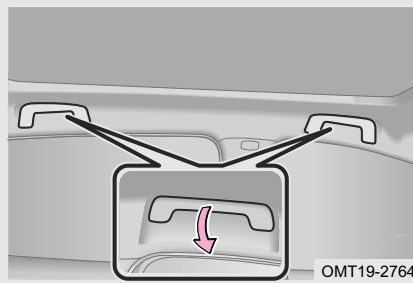

Assist grips are installed above front passenger door and both rear passenger doors respectively.

An assist grip installed on the ceiling can be used to support your body while sitting on the seat.

⚠ CAUTION

- Do not use the assist grip when getting in or out of the vehicle or rising from your seat.
- To prevent damage to the assist grip, do not put a heavy load on the assist grip.

Coat hooks

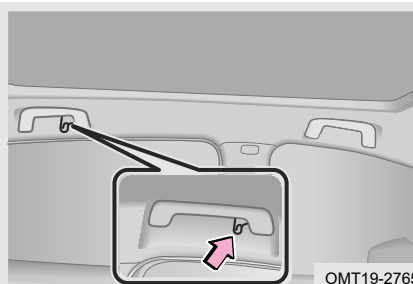

Coat hooks are provided with the rear assist grips.

⚠ CAUTION

Do not hang coat hangers or other hard or sharp objects on the hooks. If the Curtain side airbags deploy, these items may become projectiles, causing death or serious injury.

3. INTERIOR FUNCTION

3-9. Storage Space

Storage Space

Door storage boxes

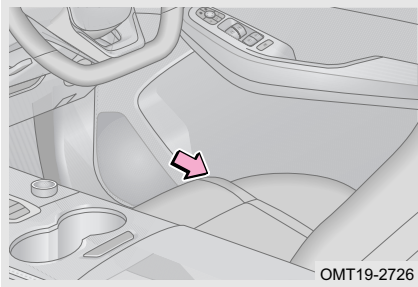

Door storage boxes on front and rear doors can be used for storing maps, cups and other items.

Glove box

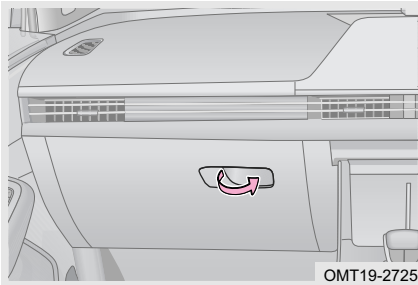

Glove box is used to store map, instructions and other items.

WARNING

Before driving, make sure that the glove box is closed in place. Otherwise in case of emergency braking or emergency steering, it may cause accidents and serious injury or even death.

Seat storage bags

Front seatbacks are both equipped with storage bags on backside, which are used to store documents, instruction etc.

Auxiliary fascia console storage box

Auxiliary fascia console storage box is used to store map, instructions and other items.

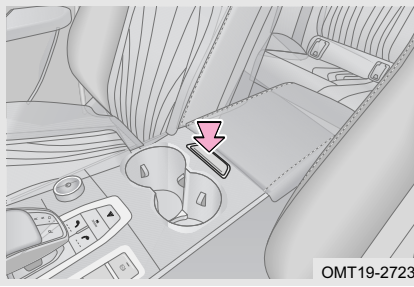

Press the switch and lift the lid to open the auxiliary fascia console storage box.

⚠ WARNING

- Adults or children are not allowed to sit on the auxiliary fascia console storage box.
- Auxiliary fascia console storage box must be closed when the vehicle is running, or it may hinder the driver's arm movement and cause injury.

Cup holders

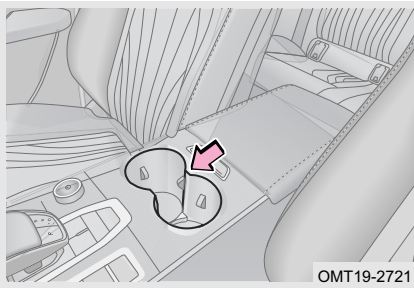

Front cup holder is located on the auxiliary fascia console.

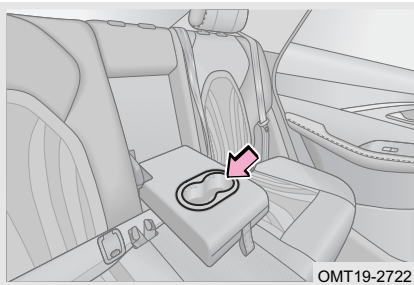

Rear cup holder is located on the rear center seatback.

⚠ WARNING

- Cover the cup or drink can firmly to prevent water or drinks from spraying out.
- Do not place anything other than cups or drink cans in cup holders to prevent these items being thrown out of the holders in the event of an accident or sudden braking, causing injury.

3. INTERIOR FUNCTION

Luggage compartment

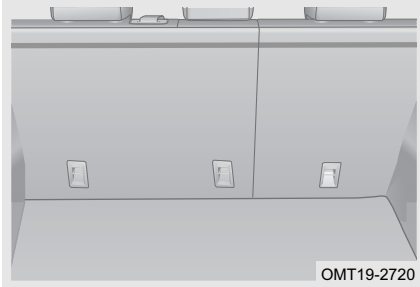

The split folding rear seats provide convenience for storage of cargo (for details, refer to "Seats").

- When stowing luggage in the vehicle, observe the following precautions:
 - Be careful to keep the vehicle balanced.
 - For better fuel economy, do not stow unneeded items.
 - Make sure that the stowing items are not oversize to prevent the boot door from closing properly.

WARNING

- Do not drive with the boot door open or not closed, to prevent items from being thrown out to cause personal injury.
- Do not allow anyone to sit in the luggage compartment. The passengers should sit in their seats with their seat belts properly fastened. Otherwise, they may face serious injury in event of sudden braking or a collision.
- Do not stack goods or luggage higher than seatback. Keep them low, as close to the floor as possible to prevent them sliding forward in event of braking, causing personal injury.

3-10. Power Outlet

Power Outlet

Front power outlet

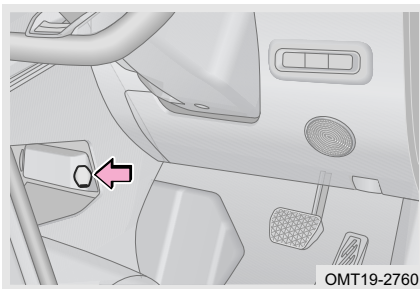

Front power outlet is located on the lower front part of auxiliary fascia console.

Power outlet can be used only when vehicle power is switched to ACC/ON mode.

Rear power outlet

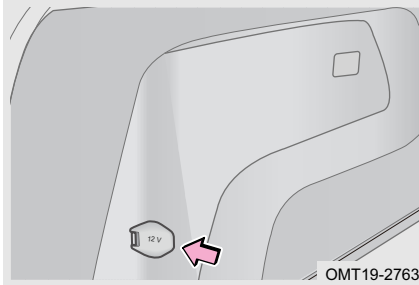

Rear power outlet is located on the left of luggage compartment.

Power outlet can be used only when vehicle power is switched to ACC/ON mode.

CAUTION

- To prevent the fuse from being blown, do not use electrical equipment that require more than 120 W (DC 12 V, 10 A).
- To prevent the battery from depleting, do not use the power outlet longer than necessary when the engine is not running.
- Do not insert anything or allow any liquid to get into the outlet other than an appropriate plug, as this may cause electrical failure or short circuits.

USB Port

Front USB port

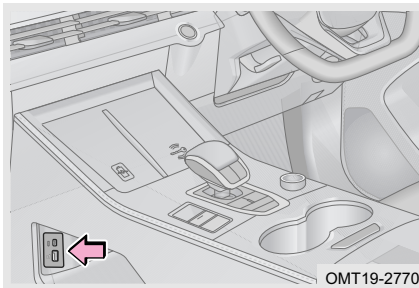

USB port is located on the lower front part of auxiliary fascia console.

USB port "  ": It is the Type-C interface. Only use USB devices that have a maximum power consumption of 60 W or below.

USB port "  ": It can be used for reading U disc, phone-link and charging the electrical equipment with low power, such as phone etc. Only use USB devices that have a maximum power consumption of 10.5 W or below.

3. INTERIOR FUNCTION

Rear USB port

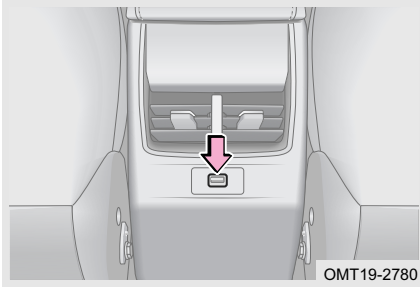

Rear USB port can be used for charging the electrical equipment with low power, such as phone etc.

USB port is located under the rear air outlet of center armrest.

Only use USB devices that have a maximum power consumption of 10.5 W (DC 5 V, 2.1 A) or below.

Rear view mirror base USB port

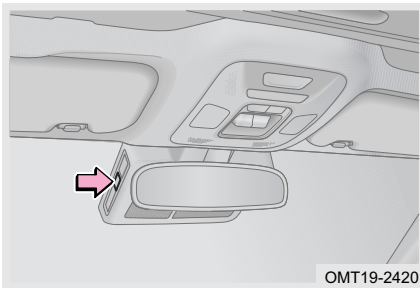

Rear view mirror base USB port can be used for driving recorder (dashcam).

Only use USB devices that have a maximum power consumption of 10.5 W (DC 5 V, 2.1 A) or below.

3-11. Sun Visors and Vanity Mirrors

Sun Visors, Vanity Mirrors and TicketClips

Sun Visors

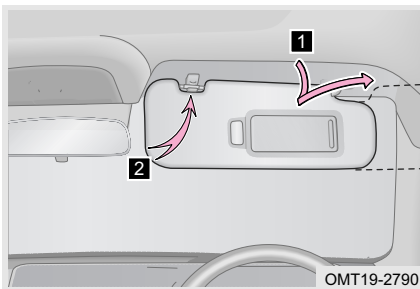

Horizontally move the vanity mirror sliding plate to use the vanity mirror.

For vehicle equipped with vanity mirror light, the corresponding vanity mirror light will come on when opening the vanity mirror.

1 Flip the sun visor down.

2 Detach the hook and turn it outward to shade sidelight.

Vanity Mirrors

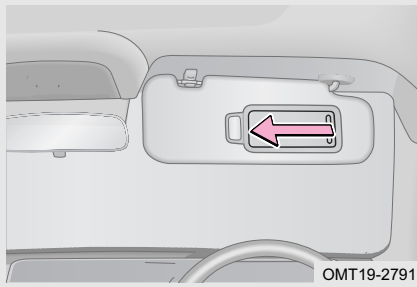

Slide the cover to open.

For vehicle equipped with vanity mirror light, the corresponding vanity mirror light will come on when opening the vanity mirror.

TicketClips

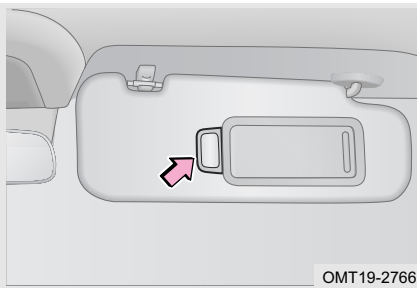

TicketClips are provided with the sun visors.

Fold down the sun visor for use.

3-12. Bonnet

Opening/closing the bonnet

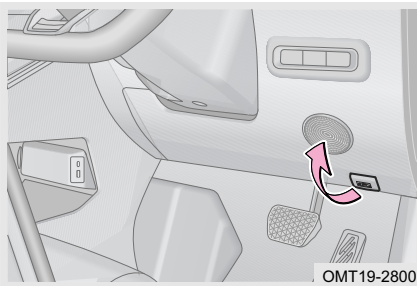

Step 1: The bonnet will spring up slightly when the bonnet release lever is pulled.

3. INTERIOR FUNCTION

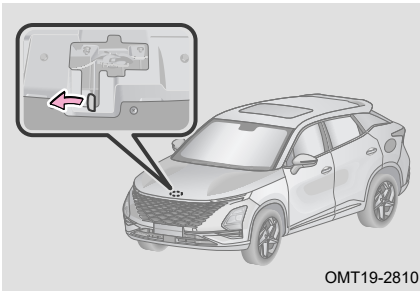

Step 2: Reach your hand to the center part of the front of the bonnet, and contact with the auxiliary catch lever. Then push it to left and keep it in this position, and lift the bonnet at the same time;

Step 3: Lower the bonnet and close it until the latch is locked;

Step 4: After closing the bonnet, lift it slightly to confirm it is closed properly.

CAUTION

- Before closing the bonnet, check if you have not left any tools, rags etc. in the engine compartment.
- When closing the bonnet, do not press it by hand, otherwise it may be deformed.
- Make sure that bonnet is closed before driving, otherwise accidents and personal injury may occur.

3-13. Boot Door

Manual Boot Door

Opening/closing boot door

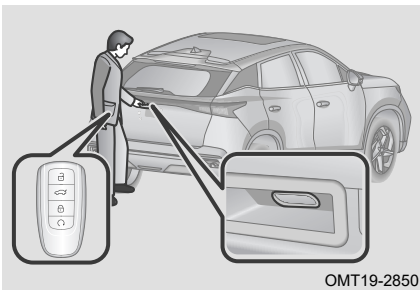

Method 1: With central lock unlocked, approach the back of vehicle, press exterior switch on the boot door and lift up to open the boot door.

Method 2: With central lock locked, approach the back of vehicle when carrying smart key, press exterior switch on the boot door and lift up to open boot door.

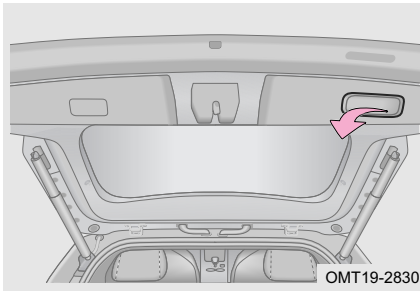

Pull the boot door assist handle down and release it before the boot door is fully closed. Make sure it is fully closed before leaving the vehicle.

WARNING

Make sure that the boot door is closed before driving, otherwise, it may result accidents and damage.

Power Boot Door

For your convenience, power boot door has following functions: Opening height adjustment, one button open/close, manual open/close, boot door stop, etc.

Boot door opening switch

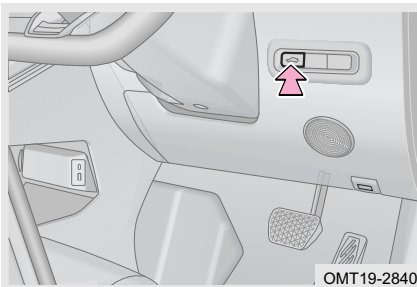

With central control lock unlocked, long press "  " switch, indicator signal lights will come on and power boot door will be opened/closed.

Boot door exterior switch

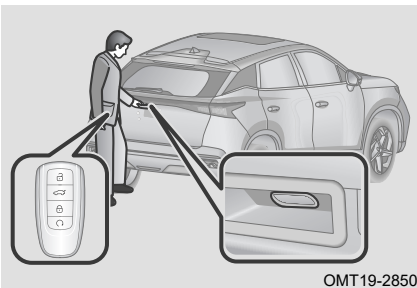

Method 1: With central control lock unlocked, approach the back of vehicle and press exterior switch on the boot door, indicator signal lights will come on and power boot door will be opened/closed.

Method 2: With central lock locked, approach the back of vehicle when carrying smart key and press exterior switch on the boot door, indicator signal lights will come on and power boot door will be opened/closed.

3. INTERIOR FUNCTION

Boot door interior switch

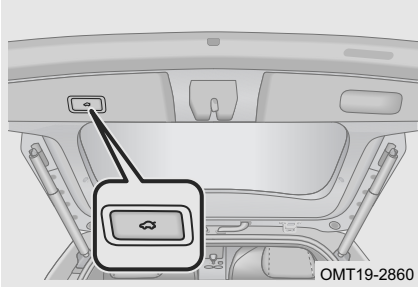

When the power boot door opens, press "🚗" switch to close it.

When the power boot door is moving, press "🚗" switch to suspend the action.

After the power boot door button is pressed, adjust it to your desire height; long press "🚗" switch until the vehicle gives a light prompt, and the power boot door opening height is set successfully.

READ

- If the boot door opening is too low, the boot door opening height cannot be set.
- Boot door opening height can also be set in audio system (for details, refer to "Audio System").

Smart key remote control

While vehicle power is switched to OFF/ACC mode, long press boot door opener button on smart key, power boot door will be opened/closed.

 CAUTION

- If the boot door fails to operate correctly, please go to authorized service centre for inspection and repair in time.
- When the boot door opens, do not pull electric support rod laterally, which may cause damage to related parts.
- Before opening the boot door, be sure to note that there should be nothing in the opening range, which could result in scratching the boot door.
- When the boot door is opened to the highest position, it cannot be pushed or supported by hand to higher place, as this may cause damage to related parts.
- Before driving, make sure that the boot door is closed properly, otherwise it may cause accidents and damage to related parts.
- When closing boot door by hand, operate gently, do not operate with brute force, which may damage motor and module.
- When closing the boot door, make sure that nobody will be caught. If closing is temporarily paused, close it again.
- When washing car with car washing device or high pressure cleaner, please make sure that smart key is not within the detection area of power boot door to prevent boot door from opening unexpectedly.
- When going uphill or downhill, due to change in the center of gravity, the boot door may not open or close. This is normal. Open or close it by hand.
- When ambient temperature is low, power boot door support rod may not support boot door automatically. In this case, lift boot door manually to open it. If boot door is frozen or covered by snow, do not open it forcibly. Turn on heater after engine starts, and do not open the boot door until the temperature in vehicle rises. If it must be opened in an emergency, wait until ice melts and freezing position is defrost to open it.

 WARNING

- Although the vehicle is equipped with jam protection function, do not activate jam protection function on purpose to avoid accidental injury.
- Before driving, the boot door must be closed, otherwise it may cause accidents and damage to related parts.
- When opening the power boot door, please be careful to avoid injury. Please make sure there is nobody within opening range of boot door. Failure to do so may cause personal injury.

Boot door jam protection function

If the boot door encounters resistance (such as children, luggage, etc.), boot door operates in the opposite direction until it is fully opened/closed, which is effective in preventing child injury and vehicle damage.

3. INTERIOR FUNCTION

Protection mode function

If multiple jam protections occur when opening and closing the boot door, it may not operate in order to protect the motor and system, so you will need to close the boot door by hand.

Boot Door Emergency Opening

Boot door cannot be opened when battery is depleted or under similar conditions. In this case, the boot door can be opened with emergency device switch.

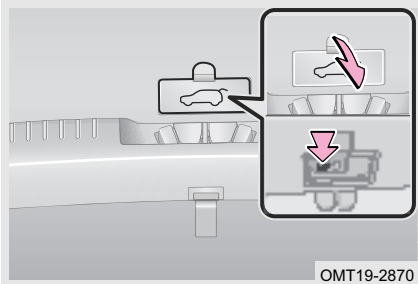

Step 1: Stop the vehicle as safely as possible;

Step 2: Fold the rear seatback;

Step 3: Get in the rear of vehicle and open emergency device cover;

Step 4: Press the emergency switch and then push the boot door to open it.

3-14. Fuel Tank Cover

Fuel Tank Cover

Manual Fuel Tank Cover

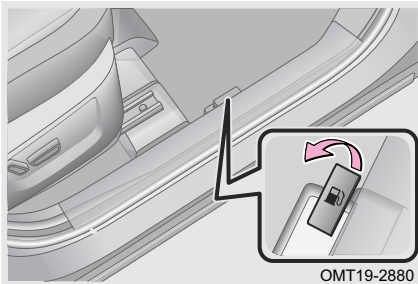

Step 1: Pull fuel tank cover opening handle and the fuel tank cover will pop up outward;

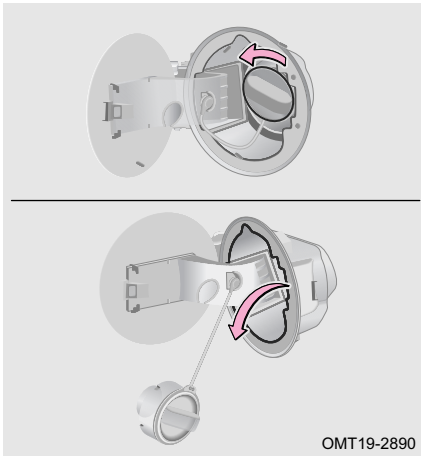

Step 2: Turn fuel filler cap counterclockwise to remove it;

Step 3: After refueling, turn fuel filler cap clockwise until a "click" sound is heard;

Step 4: Close fuel tank cover.

READ

Fuel may pollute environment. Therefore, any spilled fuel should be collected and disposed by a professional.

CAUTION

- A slight whooshing sound may be heard when the fuel tank cover is opened. This is normal.
- Never add diesel to fuel tank.
- If fuel overflows during refueling, wipe it off immediately to avoid damage to vehicle paint surface.
- After fuel filler cap is tightened firmly, loosen your hand and the cap will turn slightly in the opposite direction. This is normal.
- To prevent damage to the cap, apply force only in the direction of rotation. Do not pull or pry off it.
- During using, if fuel tank cover is not closed, drive vehicle to a safe area and stop, then close the cap again!

3. INTERIOR FUNCTION

WARNING

- Before refueling, turn ENGINE START STOP switch off and close all doors and windows.
- Make sure that the fuel filler cap is tightened securely to prevent fuel spillage, causing an accident.
- Because petrol is extremely flammable, smoking is prohibited when refueling, and there must be no other sparks or open flames.
- Do not remove the fuel filler cap quickly when opening it. In hot weather, if cap is removed suddenly, high-pressed fuel vapor may be ejected from the filler neck and cause personal injury.
- Do not inhale vaporized fuel, as the fuel contains substances that are harmful for the health.
- After exiting the vehicle and before opening the fuel tank cover, touch an unpainted metal surface to discharge any static electricity. It is important to discharge static electricity before refueling because sparks resulting from static electricity can cause fuel vapors to ignite while refueling.
- Do not attempt to continue to refuel after the fuel gun is automatically turned off! Otherwise, the fuel tank may be too full, causing fuel to overflow the fuel tank, which can easily cause fire, explosion and serious injury.

4-1. Vehicle Power Mode	4-4. Steering System
ENGINE START STOP Switch 122	Electric Power Steering System (EPS) 129
4-2. Starting and Turning off Engine	4-5. Brake System
Normal Starting and Turning off..... 123	Electric Parking Brake System (EPB)..... 131
Starting and Turning off in Emergency 124	Automatic Parking System (AUTO HOLD)..... 133
Petrol Particulate Filter (PPF) (If Equipped) 125	Vacuum Booster 135
Adaptive Engine Control System 126	Brake 136
4-3. Transmission	4-6. SRS Airbags
Automatic Transmission 126	SRS Airbags..... 137

4. DRIVING VEHICLE

4-1. Vehicle Power Mode

ENGINE START STOP Switch

When the system detects the legal smart key and the brake pedal is released, press the ENGINE START STOP switch to switch the power mode of vehicle (-each time the ENGINE START STOP switch is pressed, the mode is switched once).

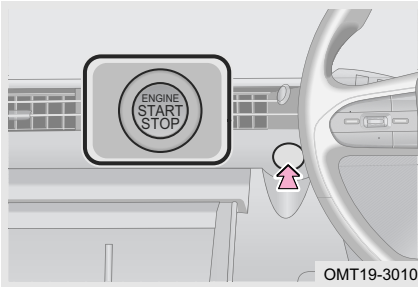

OFF mode: All electrical appliances turn off.

ACC mode: Part of electrical appliances can be used.

ON mode: All electrical appliances can be used.

START mode: When vehicle power source is turned to ACC/ON mode, depress the brake pedal and transmission gear is in P. The power of vehicle is switched to START mode and the engine can be started by pressing the ENGINE START STOP switch.

READ

- If ENGINE START STOP switch is not pressed properly, vehicle power mode can not be switched on and the engine may not be started.
- Do not place smart key on to the "key" mark, because if there is sufficient power in the battery, it may trigger an instrument alarm ("Smart key not detected", "Verify successfully, start ready") and cause confusion to the driver.

CAUTION

- When engine is not running, switch the vehicle power mode to OFF mode to prevent the battery from being depleted.
- When engine is running, if smart key is removed, engine will not turn off automatically, anti-theft horn sounds 6 times and meter displays "Smart Key Not Detected".
- When engine is running, if shift lever is shifted to R/N/D, turn off the engine and vehicle power will be switched to ACC mode other than OFF mode. Shift the shift lever to P, vehicle power will be switched to ON mode, and press ENGINE START STOP switch again to switch it to OFF mode.

Auto power off function

When engine is not running, if vehicle power is switched to ON mode for 1 hour or more, vehicle power will be automatically switched to OFF mode (the

shift lever of a vehicle with automatic transmission will be shifted into P), this function cannot completely prevent battery from being depleted.

4-2. Starting and Turning off Engine

Normal Starting and Turning off

Before starting engine

Step 1: Check surroundings of vehicle before getting in;

Step 2: Adjust seat position, seatback angle, head restraint height and steering wheel angle;

Step 3: Adjust angles of the inside and outside rear view mirrors;

Step 4: Turn off any unnecessary lights and electrical appliances;

Step 5: Fasten the seat belts;

Step 6: Confirm that the parking brake is applied;

Step 7: Shift the shift lever to P;

Step 8: Vehicle power switches to ON mode, check if malfunction indicator and other indicators on meter are normal; if they are abnormal, contact authorized service centre immediately for inspection and repair.

Starting engine

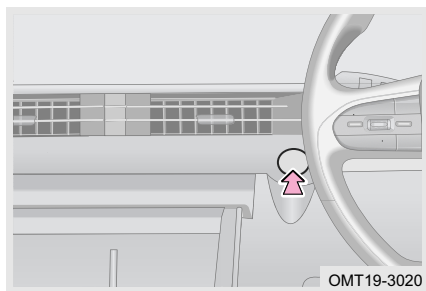

Smart key is carried on your person or put it into vehicle, and it can be detected normally:

Step 1: Shift the shift lever to P;

Step 2: Vehicle power switches to ACC/ON mode, depress brake pedal, and indicator comes on in green at the same time;

Step 3: Press ENGINE START STOP switch to start the engine.

READ

- When operating ENGINE START STOP switch, one short, firm press is enough.
- The vehicle is equipped with an alcohol lock, which needs to be installed at after-sales authorized service centre.

After starting engine

Engine idle speed is controlled by electronic control system. When engine is started, high speed can help to increase engine temperature, this is normal. After engine temperature increases, speed will automatically drop down to

4. DRIVING VEHICLE

normal speed. If not, please contact authorized service centre for inspection and repair.

WARNING

Exhaust gas contains harmful substances which may lead to a serious health hazard when inhaled. Use the following methods to avoid inhaling exhaust gas:

- Do not run the engine for prolonged periods of time in an unventilated area, such as in a garage, etc.
- When running engine in a ventilated with vehicle stopped, switch air conditioning to outer circulation, and set high blower speed.

Turning off engine

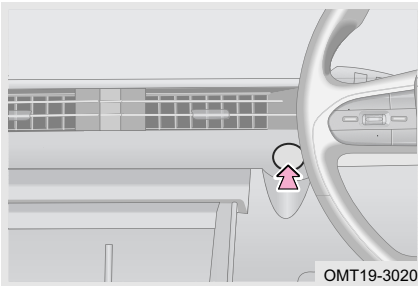

Step 1: Stop the vehicle and apply parking brake;

Step 2: Shift the shift lever to P;

Step 3: Press the ENGINE START STOP switch;

Step 4: Check that engine is turned off.

CAUTION

- Do not depress accelerator pedal before engine is turned off.
- After driving at high speed for prolonged periods of time engine temperature will be high. Do not turn off engine immediately when stopping vehicle. Allow the engine to idle for several minutes, and then turn off engine after its temperature drops. Otherwise, engine may be damaged.

Starting and Turning off in Emergency

Starting engine in emergency

When smart key battery is low or signal is seriously interrupted, engine start stop function will not work normally. In this case, start engine according to following steps:

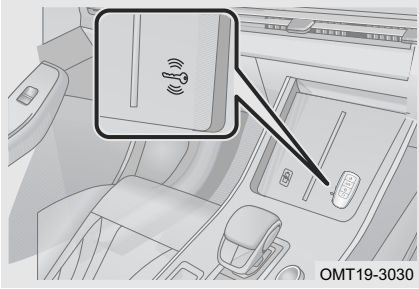

Step 1: Lay smart key on front end of auxiliary fascia (as shown in figure) with front side facing up; do not depress brake pedal at this time;

Step 2: Switch vehicle power supply to ACC/ON mode, depress the brake pedal;

Step 3: Press ENGINE START STOP switch to start the engine.

Note: For vehicle with automatic transmission, vehicle power is switched to ACC mode, when the engine cannot be started by depressing brake pedal, long press ENGINE START STOP switch for 15 seconds or more, system will ignore brake pedal signal and engine also can start at the same time (it is not recommended to use this function to start driving again unless special circumstances occur).

READ

The interior designs are different according to the configuration of the vehicle. Please refer to the actual vehicle.

CAUTION

Do not place smart key on to the "key" mark, because if there is sufficient power in the battery, it may trigger an instrument alarm ("Smart key not detected", "Verify successfully, start ready") and cause confusion to the driver.

Turning off engine in emergency

When vehicle systems are normal during traveling, if engine has to be stopped in case of an emergency, perform as follows:

Method 1: Shortly and continuously press ENGINE START STOP switch 3 times or more within 2 seconds.

Method 2: Press and hold ENGINE START STOP switch for 3 seconds or more.

Petrol Particulate Filter (PPF) (If Equipped)

PPF can capture particulate emissions from exhaust gas to reduce the effect of particulate emissions of vehicle. When particulate emissions from the PPF is accumulated to a certain extent, the system will regenerate PPF with a specific strategy.

Avoid engine idling for prolonged periods of time when green indicator " " on instrument cluster comes on. Increase the vehicle speed (vehicle speed is no less than 37 mph (60 km/h)) until the indicator goes off in the case of safety

4. DRIVING VEHICLE

and compliance. Yellow indicator "  " on instrument cluster comes on, indicating that particulate emissions captured by PPF have reached to its limit, please contact authorized service centre for inspection and repair.

■ Observe the following precautions during daily driving:

1. Avoid driving for short distance frequently.
2. Avoid idling for prolonged periods of time or frequently.
3. Avoid running the engine at low speed and high throttle for prolonged periods of time or frequently.

WARNING

Do not stop, idle for prolonged periods of time at areas covered by dry leaves, dry grass or other inflammables. The exhaust pipe is at high temperature when engine is running or just after vehicle is stopped, which may lead to fire.

Adaptive Engine Control System

If the battery terminal is removed and reconnected, the vehicle power is switched to ON mode, and vehicle power will be switched to OFF mode after waiting for 15 s before starting the engine.

Abnormal phenomena (such as, engine shaking or unsmooth starting off) may occur in early driving stage, which is a normal phenomenon that engine control system is learning to adapt to engine again.

4-3. Transmission

Automatic Transmission

The automatic transmission belongs to the electronically controlled hydraulic automatic transmission with manual and automatic shift modes.

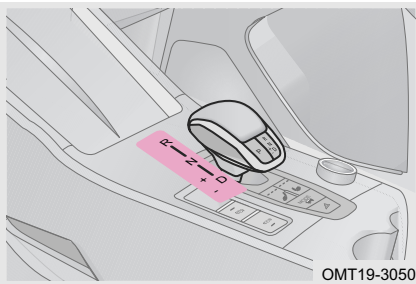

Operation method

Step 1: Depress the brake pedal completely, then shift the shift lever from P to D;

Step 2: Release the parking brake manually or automatically and release the brake pedal to drive the vehicle slowly.

READ

Press P button on shift lever to shift to P. Push the shift lever forward and backward to shift to other positions (R, N, D).

Gear position introduction

During the operation, the driver can choose the automatic mode (P, R, N, D) and the manual mode M (+, -). The selected gear position will display the corresponding gear information on the information display area in instrument cluster.

Automatic mode: When the transmission gear is in D, vehicle upshift and downshift automatically according to speed. All are done without manual intervention.

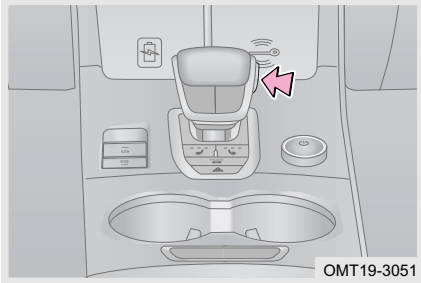

Manual mode: When the transmission gear is in D, press and hold the M switch to enter manual mode M (+, -), push forward to upshift by one gear and push backward to downshift by one gear.

The following information will help you understand purpose and operation procedures of different gears to make a right choice according to actual demand during operation.

Gear Range		Function
P (Park)		This is park position. Drive wheels are mechanically locked. Engine can be started.
R (Reverse)		This is a reverse position. Reverse lights will come on and parking radar system will operate.
N (Neutral)		This is a neutral position. It is used for short time idling stop.
D (Forward Drive)		This is a forward driving position. Automatically shift up and down among all forward drive gears according to engine load and vehicle speed.
M (Manual mode)	+	Push shift lever toward + once, transmission will raise one gear.
	-	Push shift lever toward - once, transmission will lower one gear.

4. DRIVING VEHICLE

CAUTION

- In manual mode, when the speed does not change, Kick-down operation is allowed, and automatic up-shifting is not allowed.
- Never shift in P position when the vehicle is not stopped steadily. This may lead to abnormal sound or damage to the transmission.
- When engine stalls, do not coast vehicle in N. Otherwise, the transmission will be damaged.
- Do not shift the shift lever out of D while the vehicle is moving forward. Otherwise, the transmission may be damaged seriously.
- Do not shift the shift lever out of R while the vehicle is moving backward. Otherwise, the transmission may be damaged seriously.
- When shifting the shift lever out of P, it is necessary to depress the brake pedal first to stop the vehicle steadily, and then perform shifting among each gear position. Otherwise shifting mechanism will be damaged.
- When vehicle malfunctions occur due to insufficient battery and even depressing the brake pedal or shifting out of P is impossible, please contact a authorized service centre immediately for inspection and repair.
- In manual mode, when engine speed reaches to the highest speed, it shifts up automatically; when engine speed is excessively low, it shifts down automatically; when vehicle brakes and slows down, it shifts down automatically.
- In manual mode, up-shifting and down-shifting operations must be performed by pushing shift lever according to engine speed and vehicle speed. If the requirements are not met, the transmission will not perform the gear shifting operation.
- When the vehicle is parked on a slope, the parking brake must be applied first, and then the shift lever is shifted into P. After starting on a slope, first shift the shift lever out of P, then release parking brake for driving.

WARNING

- Never tow the vehicle for a long distance or at high speed. Raise drive wheels or disconnect propeller shaft when towing.
- When the transmission is in N, make sure parking brake is applied or brake pedal is depressed, otherwise an accident may occur.

Transmission alarm text display (if equipped)

When the transmission temperature is high, the meter alarm text message is "- Gearbox Over Heat, Please Park In A Safe Place".

When the transmission temperature is overheated, the meter alarm text message is "Gearbox Over Heat, Please Park In A Safe Place for About 5 Minutes".

⚠ CAUTION

After the vehicle is cooled, restart the vehicle. If the vehicle alarm text prompt is still in alarm state, please immediately turn off engine and contact the authorized service centre for inspection and repair as soon as possible.

Fail-safe mode

When malfunction occurs in transmission system, fail-safe mode will be automatically activated. Simultaneously, a yellow indicator "☀" on the instrument cluster will come on and transmission cannot operate normally. The vehicle will slow down and be driven at low speed.

⚠ CAUTION

Long distance driving is not allowed in fail-safe mode. Otherwise, transmission may be damaged, go to authorized service centre for inspection and repair immediately.

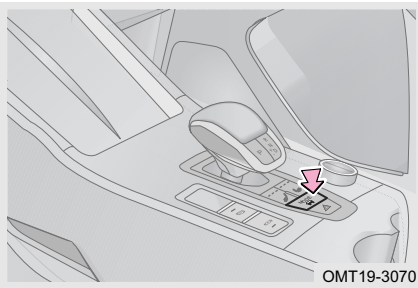
Driving mode

System is ECO mode by default when engine starts. Press drive mode switch, switch between SPORT mode, ECO mode or NORMAL mode. You can choose according to different road conditions.

Improve vehicle fuel economy in ECO mode; Improve vehicle handling, controllability and power performance in SPORT mode.

After the driver switches to ECO mode, this operation will be memorized. Last operating status of driver will be memorized by default after vehicle is powered on next time. This function is not standard. Please refer to the actual vehicle.

4-4. Steering System**Electric Power Steering System (EPS)****Introduction**

Electric Power Steering System (EPS) uses the torque generated by motor as power source of steering system, instead of a hydraulic pump driven by the engine.

Electric Power Steering System (EPS) self-learning

If the vehicle battery is powered off and reconnecting or starting, due to the initialization of electric steering system angle, the yellow indicator "☀!" on

4. DRIVING VEHICLE

instrument cluster flashes, turn the steering wheel left and right to the limit position to complete the angle reset, and the yellow indicator "🚗!" on instrument cluster turns off.

Electric Power Steering System (EPS) indicator

When there is fault in electric power steering system (EPS), yellow indicator "🚗!" on instrument cluster comes on.

⚠ CAUTION

- Frequent handling and rotation of steering wheel over long periods of time may damage the mechanism in the electric power steering system (EPS).
- It is forbidden to turn the steering wheel frequently and quickly at idle speed to prevent the system from overheating. If the system overheats, heavy steering will occur, which is normal. Stop rotating the steering wheel and switch the vehicle power to OFF/ACC mode until the system cools down.

⚠ WARNING

After electric power steering system (EPS) is disabled, although the vehicle still has the conventional steering capability, it should be driven with caution. At this time, please go to the authorized service centre for inspection and repair as soon as possible.

Steering force mode (If equipped)

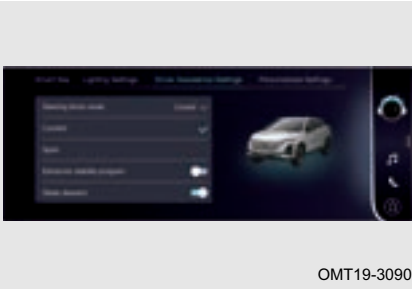

Electric power steering system (EPS) is equipped with two steering modes (Sport/Comfort). The default steering mode is comfort mode when the vehicle first works. Compared with the comfortable mode, steering force of sport mode is reduced more relaxed.

📖 READ

- The steering force mode can be correlated with the driving mode (if equipped). After the correlation, the steering force is the movement in the SPORT mode, while the steering force is the comfort in the ECO mode. After disassociation, steering force can be set to Sport/ Comfort separately.
- The steering force mode should be set on audio system . For details, refer to "Audio System".

4-5. Brake System

Electric Parking Brake System (EPB)

Introduction

Electric Parking Brake System (EPB) is a technology that integrates temporary braking during driving and long-time braking after stopping, and implements parking brake by electronic control. This technology replaces the traditional handbrake.

Usage method

■ Applying parking brake manually

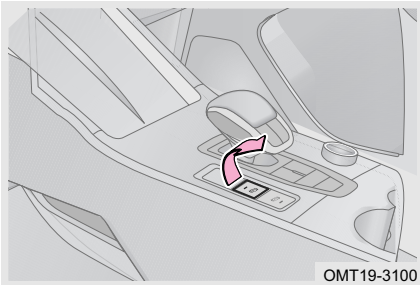

When vehicle power is switched to ON mode, or engine starts and vehicle is stopping, pull up the electric parking brake button, "Ⓟ" red indicator in instrument cluster and electric parking brake button indicator remains on, indicating parking brake function has been turned on.

After vehicle power is switched to OFF mode or the shift lever is in P, parking brake function can be applied automatically by Electric Parking Brake (EPB) system.

■ Releasing parking brake manually

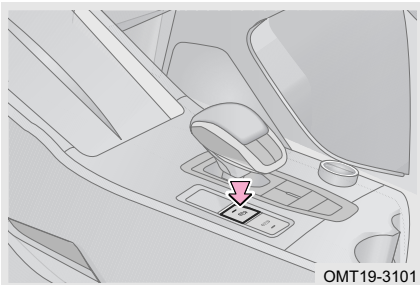

With engine starts or vehicle power is switched to ON mode, depress the brake pedal and press electric parking brake button manually, "Ⓟ" red indicator in instrument cluster and electric parking brake button indicator will turn off, indicating parking brake function has been released.

■ Releasing parking brake automatically

Fasten driver's seat belt and close driver side door. Depress accelerator pedal with shift lever in D or R on flat road to release electric parking brake automatically, and "Ⓟ" red indicator in instrument cluster goes off.

When shift lever is switched to D or R from other positions, electric parking brake is released automatically, and "Ⓟ" red indicator in instrument cluster goes off.

4. DRIVING VEHICLE

When vehicle stops on a slope, depress accelerator pedal harder to shift to D or R. When driving force is greater than slipping force, electric parking can release automatically.

READ

- When towing vehicle, it is necessary to release parking brake, and transmission is in neutral.
- The interior designs are different according to the configuration of the vehicle. Please refer to the actual vehicle.

CAUTION

- Electric Parking Brake (EPB) system and Automatic Parking system (-AUTO HOLD) can not be used when vehicle battery is lost. Jumper cables can be used to start the engine (refer to "Basic Knowledge of Vehicle Emergency" for details).
- While depressing brake pedal and releasing or applying parking brake, brake pedal may push slightly up or down, please press the brake tightly.
- When performing automatic releasing of electric parking brake, fasten the driver's seat belt and close the driver side door. Failure to do so may cause the automatic releasing conditions of parking brake cannot be satisfied.
- When enabling and releasing electric parking brake, "whooshing" sound may be heard from rear part of vehicle. This is the working sound emitted by parking brake and is normal.
- If vehicle coasts after stopping within a short period, system will increase parking brake force automatically to hold it for safety. When brake force increasing, system makes operation sound. This is normal.
- Engine starts or the vehicle power is switched to ON mode, when parking brake can not be released manually by depressing brake pedal, you can depress accelerator pedal and press the electric parking brake button to release parking brake, it is only used when parking brake can not be released manually by depressing brake pedal, pay attention to safety when using. Please go to authorized service centre for inspection and repair as soon as possible.

WARNING

To avoid accidental vehicle movement, when stopping or leaving vehicle, and after Electric Parking Brake (EPB) system operates, "(P)" red indicator in instrument cluster and electric parking brake button indicator turn off after they come on for a certain time, check whether "(P)" red indicator in instrument cluster and electric parking brake button indicator come on to ensure electric parking brake is properly applied.

Emergency braking function

If foot brake fails, pull up the electric parking brake button continuously to forcibly apply brake by parking brake. In this process, "(P)" red indicator in instrument cluster blinks. Release the button to exit emergency braking.

WARNING

- When emergency braking function is activated, it will drone. This is normal.
- When applying emergency braking, electric parking brake will apply brake at constant deceleration which is deviated from driver's desired deceleration and braking distance will be different.
- Use this function cautiously during normal driving. When driving, other passengers should not touch button accidentally. Otherwise, it may cause an accident.
- Emergency braking function can only be used in case of emergency such as foot brake failure or brake pedal stuck. Electronic Stability Control (ESP) system and its components cannot exceed road traction physical limit. Use of the emergency braking function on windy roads, dangerous roads, in heavy traffic or severe weather, may lead to drifting, side slipping or pulling, so please be careful.

Electric parking emergency releasing

When Electric Parking Brake (EPB) system operates, press electric parking brake button and depress and hold brake pedal, and vehicle power is switched to OFF mode, electric parking is released in emergency. It is recommended to use the electronic parking system only in rescue trailers or rare situations.

Automatic Parking System (AUTO HOLD)

Introduction

Automatic parking system (AUTO HOLD) is used to prevent vehicle from rolling when vehicle is stationary and starts off.

4. DRIVING VEHICLE

Usage method

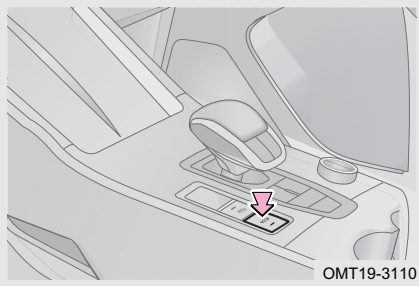

■ Automatic parking operation conditions

Engine is started, driver side door is closed properly and driver seat belt is fastened.

■ Turning on automatic parking

When automatic parking conditions are met, press automatic parking button, indicator on button remains on, showing that vehicle has turned on automatic parking function, and the white automatic parking indicator in instrument cluster remains on.

■ Activating automatic parking function

When automatic parking function is turned on, depress brake pedal, shift lever in D, vehicle is changed to stationary state from movement, automatic parking function is activated, "Ⓐ" green indicator in instrument cluster remains on.

Depress brake pedal when vehicle is stationary, and the automatic parking function is turned on at the same time and the condition of automatic parking is met, then automatic parking function is activated, "Ⓐ" green indicator in instrument cluster remains on.

■ Turning off automatic parking

When the automatic parking function is turned on, press the automatic parking button to turn off automatic parking function. The indicator on the automatic parking button turns off, and white automatic parking indicator in instrument cluster turns off, indicating that the vehicle has exited the automatic parking function.

When automatic parking function is activated, press automatic parking button to turn off automatic parking function, "Ⓐ" green indicator in instrument cluster and indicator on automatic parking button turn off, indicating that vehicle has exited automatic parking function and switched to parking brake function.

■ Automatic parking release function

Way to release automatic parking is the same as that of electric parking brake, including manual release and automatic release.

READ

- The interior designs are different according to the configuration of the vehicle. Please refer to the actual vehicle.
- According to the configuration of the vehicle, the automatic parking indicator displays different. Please refer to the actual vehicle.

 CAUTION

- This function can only be activated when shift lever in D, not in R.
- Turn off automatic parking function before driving into car wash.
- Always park vehicle correctly according to safety regulations and take care to avoid hurting yourself and pedestrians.
- If accelerator pedal is depressed very slowly, automatic parking release delays. This is normal.
- When automatic parking function is activated, open driver side door or unfasten driver side seat belt, automatic parking will switch to electrical parking.
- When automatic parking function is enabled, open driver side door or unfasten driver side seat belt to exit automatic parking function, close the door or fasten the belt again to activate the function again.
- After automatic parking is enabled, the automatic parking system will automatically stop the vehicle from the state of motion to a complete stop by foot brake, but the transmission gear is still in D or R. It is recommended to shift to N for a short time and shift to P for prolonged periods of time.

 WARNING

To avoid vehicle accidentally moving, in the state of automatic parking, confirm shift position before depressing accelerator pedal to start.

Vacuum Booster

The vacuum booster is controlled by engine vacuum and it works only when the engine is running. Therefore, do not coast your vehicle with engine off.

 WARNING

Do not coast your vehicle with engine off while driving downhill. To achieve better braking effect, shift to low gear before driving downhill.

If the vacuum booster does not work because vehicle is being towed or malfunctioning, brake pedal should be depressed more firmly than usual to compensate booster braking effect.

In normal temperature, we recommend allowing the engine to idle for 15 seconds after the vehicle starts, if the temperature is lower, the time is longer. This is to allow it to quickly heat and to activate the three-way catalysts and improve waste gas conversion efficiency. It can also help restore the brake vacuum if the vehicle has been parked for prolonged periods of time. We advise idling the engine for 15 seconds each time you start the vehicle.

4. DRIVING VEHICLE

Brake

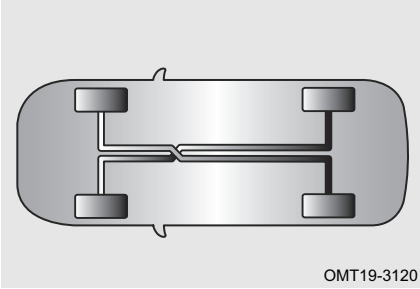

The brake system adopts X type arrangement, double circuit brake system; The system is a hydraulic system with two independent subsystems. If one of the subsystems fails, the other system can still perform brake function. However, the brake pedal should be depressed more firmly than usual and the braking distance will increase, and the brake system malfunction indicator remains on.

WARNING

Do not drive vehicle under conditions in which only one brake system works. Please go to authorized service centre as soon as possible.

Brake system indicator

When there is fault in brake system, red indicator "" on instrument cluster remains on.

WARNING

When there is fault in brake system, check the brake fluid level, add brake fluid when it is lower than MIN line. If reason is unclear, go to authorized service centre immediately.

Precautions for brake system

Be sure to read the following precautions when using the brake system:

1. If there is a continuous shaking or vibration to the steering wheel while braking, please go to authorized service centre for inspection and repair immediately.
2. When driving downhill, shift to a low gear to make full use of engine braking effect and avoid continuous use of brakes. Failure to do so may cause the brakes to overheat, making braking distances longer and in serious cases may mean a temporary loss in brake effectiveness.
3. The brake system will make some noises sometimes during operation, which is normal, but if you hear metal friction or a whistling sounds for prolonged periods of time, the brake linings may be seriously worn, and you must go to a authorized service centre for replacement immediately.
4. The new brake linings must be break-in to reach optimal brake effect. Braking effect in the first 124 miles (200 km) is not optimal. In this case, depress brake pedal more firmly to compensate braking effect.

5. A wet brake may cause abnormal vehicle deceleration or pull to one side when braking. Depress brake pedal slightly to test effectiveness of brake. After driving through deep water, keep a safe vehicle speed and depress brake pedal slightly until braking function is restored.
6. Wear condition of brake linings largely depends on its working conditions and driving style. For vehicles mainly used in city traffic, frequent starting and stopping will make working condition of brake linings worsen. Therefore, please go to authorized service centre according to specified maintenance mileage to check thickness of brake linings or replace it as needed.

4-6. SRS Airbags

SRS Airbags

In severe frontal/side collision the SRS airbags deploy and work together with seat belts to protect occupants in vehicle. SRS airbags can distribute impact force more evenly to upper parts of occupants' body, so their body move slowly even stop, thus reducing the risk of passenger and driver injury. Once an SRS airbag is deployed, doors will automatically unlock, interior lights will illuminate and hazard lights will illuminate.

Location of SRS Airbags

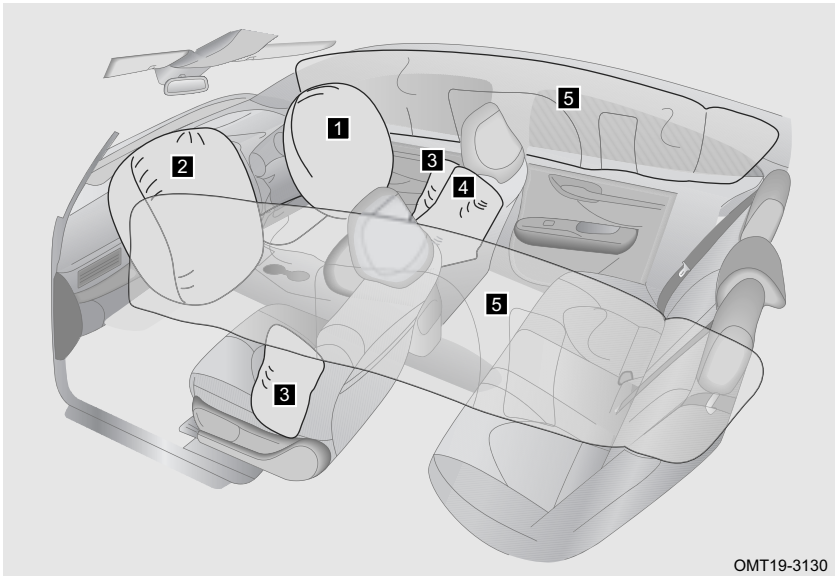

4. DRIVING VEHICLE

- 1 Driver airbag
- 2 Front passenger airbag
- 3 Front side airbags
- 4 Front middle airbag
- 5 Curtain shield airbags

Airbag (SRS) Introduction

■ Driver airbag / front passenger airbag

In an event of a severe frontal collision and the airbag deployment conditions are met, both driver airbag and front passenger airbag work together with seat belts to help reduce injuries to the head or chest of driver and front passenger caused by hitting the interior component. (For models equipped with front passenger airbag switch, the front passenger airbag does not deploy when the switch is off).

■ Front side airbags

In an event of a severe side collision and the airbag deployment conditions are met, front side airbags can help protect the torso of the front seat occupants.

■ Curtain shield airbags

In an event of a severe side collision and the airbag deployment conditions are met, curtain shield airbags can help protect primarily the head of occupants in the outer seats.

■ Front middle airbag

In an event of a severe side collision and the airbag deployment conditions are met, curtain shield airbags can help protect primarily the head of driver and front passenger.

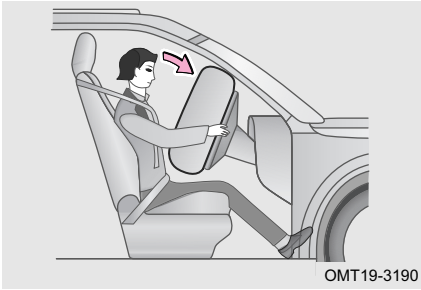

The SRS airbag works together with seat belt to protect safety of driver and passengers. However, airbag is not a substitute for seat belt. In addition, the SRS airbag will deploy only when the collision degree of vehicle reaches the design condition. In some collisions, seat belts are the only protective device. Wearing a seat belt during a collision can help reduce the risk of hitting objects inside the vehicle or being thrown out of the vehicle, and effectively protect the drivers and passengers. Therefore all people in vehicle should wear seat belts correctly. SRS airbags and seat belts can provide protection only for adults but are not designed to protect infants and young children.

The SRS airbag will generate considerable force at the moment of deployment. In order to avoid injury caused by deployment of the SRS airbag, the driver and occupants must adopt the correct sitting posture, correctly wear the seat belt and adjust their seat position, never get too close to the SRS airbag, such as sitting on the edge of the seat or tilting the body forward. For vehicles equipped with front side airbag and curtain shield airbag, make sure that the arms are sufficiently away from the vehicle side to avoid injury during deploying.

4. DRIVING VEHICLE

CAUTION

- The SRS airbag cannot protect the lower part of the occupant's body.
- The SRS airbag will quickly contract after deploying, which can ensure that forward vision of driver is not blocked.
- The related parts of SRS airbag will generate heat after deploying. Do not touch the related parts of SRS airbag immediately to avoid injury.
- The SRS airbag is a non-reusable device. Once the SRS airbag is deployed, the related parts of SRS airbag must be replaced.
- If the areas where the SRS airbags are stored, such as the steering wheel and instrument panel are damaged or cracked, please go to authorized service centre for replacement as soon as possible.
- The deployment and contraction of the SRS airbag is completed in a short period of time, and cannot protect against the impact of a second impact that may occur subsequently.
- The SRS airbag is neither designed for rear collisions, slight frontal collisions, nor for vehicle rolling over, and it does not work when the vehicle is braked in an emergency.
- The SRS airbags release some smoke and dust after deploying. For people with asthma or other respiratory problems, respiratory system could be stimulated. Therefore, all people in vehicle should get out as soon as possible, or open windows to breathe fresh air and seek medical treatment if necessary.

⚠ WARNING

- The seat cover should not block front side airbags and front middle airbag during using, as in the event of an accident, the front side airbags and front middle airbag will not pop up after inflating, which will reduce protection for passengers.
- A soft, dry cloth or cloth dampened with water must be used to clean the SRS airbag. In order to avoid any fluid into the SRS airbag, otherwise it may seriously affect the normal function of SRS airbag.
- If there is water in vehicle, the SRS airbag may be damaged. Even if there is no collision at this time, it may cause the airbag to deploy accidentally. Turn off the engine immediately and disconnect the negative battery cable. Do not try to start the engine. Please contact authorized service centre for inspection and repair immediately.
- Make sure driver and front passenger always sit upright. Leaning into the path of front middle airbag can prevent the airbag from deploying properly and increases your risk of injury.
- Do not attach accessories on or near the front middle airbag. They can interfere with the proper operation of the airbag, or hurt someone if airbag inflates.
- Do not open the lid of front center armrest box while driving.
- Do not cover or replace the driver's seatback cover without consulting authorized service centre. Improperly replacing or covering driver's seatback cover can prevent front middle airbag from properly deploying during a side impact.

SRS airbag indicators

The "  " red indicator on instrument cluster remains on when it is malfunctioning, which is used to alert the driver that SRS airbag is malfunctioning. Please go to authorized service centre for inspection and repair as soon as possible.

SRS airbag operating conditions

Deployment conditions of the SRS airbag do not depend on driving speed of vehicle, but depend on the object, collision direction and vehicle speed. SRS airbags may not deploy when the impact of collision is absorbed or dispersed into the body; However, the SRS airbag can sometimes operate depending on the impact condition in an accident. Therefore, deployment conditions of the SRS airbag should not be judged according to the damaged condition of the vehicle.

Even if the SRS airbag is not deployed, a collision may damage the SRS airbag in the vehicle. SRS airbags may not operate properly if damaged, and therefore will not be able to protect you and other passengers in the event of another collision, which may result in accidents and personal injuries. In order to ensure that the SRS airbag can deploy properly in an event of collision,

4. DRIVING VEHICLE

please go to authorized service centre for inspection and repair as soon as possible.

■ Conditions under which SRS airbag may deploy other than a collision

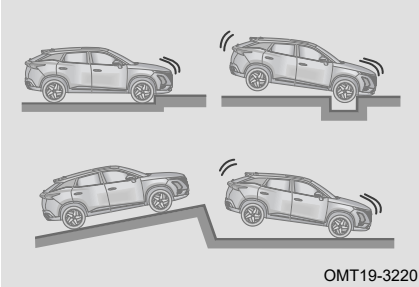

The driver airbag, front passenger airbag, front side airbags, curtain shield airbags and front middle airbag may also deploy if a serious impact occurs to the underside of your vehicle.

■ Conditions under which SRS airbag may deploy in a collision

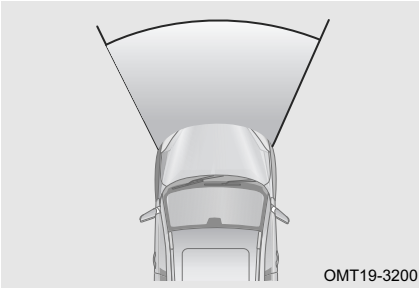

In general, in an event of frontal collision, the driver airbag and front passenger airbag will deploy if the deceleration of vehicle exceeds the designed threshold level.

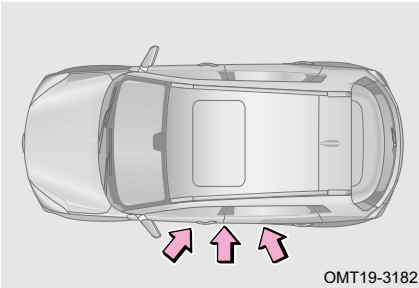

The vehicle is subjected to a strong side impact, and the side collision sensors detect an impact severe enough to cause the front side airbags, curtain shield airbags, and front middle airbag to deploy.

■ Conditions under which SRS airbag may not deploy during a collision

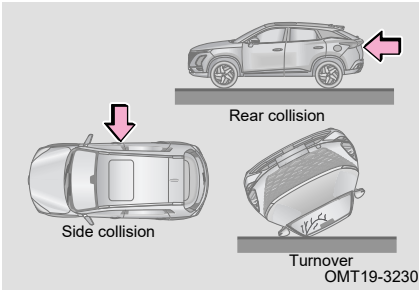

The driver airbag and front passenger airbag will usually not deploy if the vehicle is involved in a side or rear collision, if it rolls over, or if it is involved in a low-speed frontal collision.

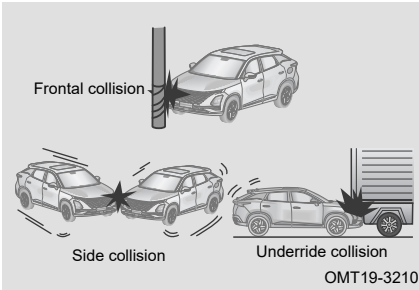

The driver airbag and front passenger airbag may not deploy if the front of vehicle hits a telegraph pole, goes under a truck, or if the vehicle is involved in an sideways collision.

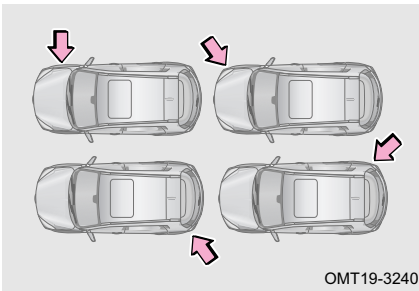

The front side airbag, curtain shield airbag and front middle airbag may not deploy if the vehicle is subjected to a collision from side, the rear part of the rear tyre or a side collision at certain angles to the vehicle.

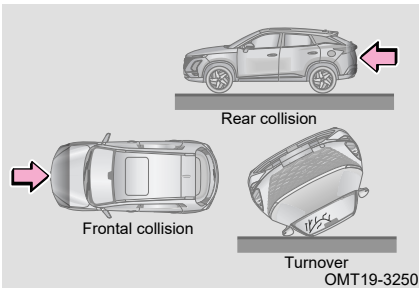

The front side airbag, curtain shield airbag and front middle airbag may not deploy if the vehicle is subjected to a front or rear collision, turnover or low speed side collision.

4. DRIVING VEHICLE

Precautions for SRS airbag



Always keep SRS airbag deployment path clear. It is forbidden to place anything (such as mobile phone) between the occupant and the SRS airbag and fix or place any objects on or near the SRS airbag cover; If there is an object between occupant and SRS airbag, the SRS airbag may not deploy according to design path, or the SRS airbag may push object to occupant's body, causing serious injury or even death.

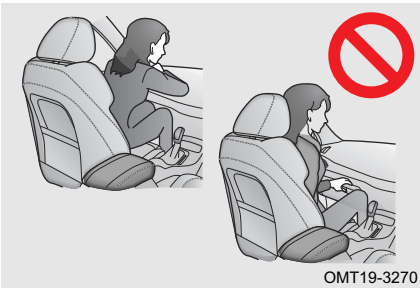

Do not sit on the edge of the seat or lean against the dashboard.



Do not allow a child to stand in front of the front passenger airbag unit or sit on the knees of front passenger.



Do not lean against the door, A pillar, B pillar or C pillar.

Do not allow anyone to kneel on the passenger seat toward the door or put their heads or hands outside the vehicle.

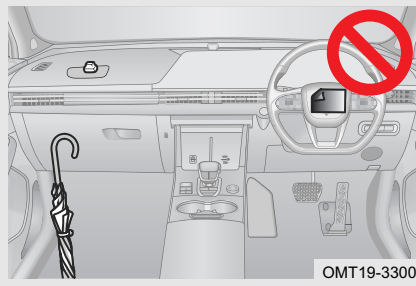

Do not attach anything to or lean anything against the areas such as the instrument panel, steering wheel and lower portion of the instrument panel. These items can become projectiles when driver airbag or front passenger airbag deploys.

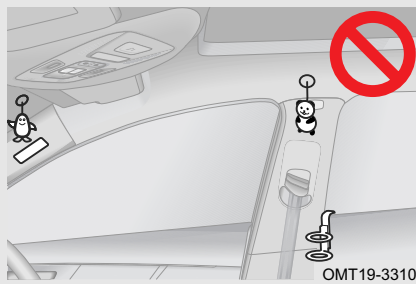

Do not attach anything to areas such as the door, windshield glass, side door glass, A pillar, B pillar, C pillar, roof side rail and assist grip.

Do not strike or apply excessive force to the area of SRS airbag components. Otherwise, it may cause SRS airbag malfunction.

Replacement of SRS airbag component

The related parts of the SRS airbag must be replaced 10 years from the date of vehicle purchase. In order to make sure that the SRS airbag can ensure your safety, please always go to authorized service centre to replace related parts of the SRS airbag within the specified time.

Make sure that the new owner knows the SRS airbag configuration and the replacement date of SRS airbag in this vehicle when the vehicle is sold.

Modification and disposal of SRS airbag components

Do not dispose of the vehicle or operate the following components without permission of the authorized service centre, otherwise accidents and personal injuries may occur:

- Modification of vehicle suspension system.
- Modification of vehicle front bumper, etc.
- Modification of side doors or door protective panel and B-pillar protective panel, etc.
- Installation, removal, disassembly and repair of airbags (SRS).
- Repair, modification, removal or replacement of steering wheel, instrument cluster, instrument panel and seats.

5-1. Speed Limit Assist System (SLA) Speed Limit Assist System (SLA) (If Equipped)	149	Rear Cross Traffic Braking (RCTB) System (If Equipped).....	164
5-2. Cruise System Adaptive Cruise Control System (ACC)	150	5-8. Automatic Emergency Braking System (AEB) / Front Collision Warning System (FCW) Automatic Emergency Braking System (AEB) / Front Collision Warning System (FCW).....	166
Active Speed Limit.....	155	5-9. Traffic Jam Assist System (TJA) / Integrated Cruise Assist System (ICA) Traffic Jam Assist System (TJA) / Integrated Cruise Assist System (ICA)	169
5-3. Hill Descent Control System (HDC) Hill Descent Control System (HDC) (If Equipped)	157	Intelligent Avoidance System.....	171
5-4. Lane Departure Warning System (LDW) Lane Departure Warning System (LDW).....	158	5-10. Drive Away Information System Drive Away Information System	172
5-5. Lane Departure Prevention System (LDP) Lane Departure Prevention System (LDP)	160	5-11. Tyre Pressure Monitoring System (TPMS) Tyre Pressure Monitoring System (TPMS)	172
5-6. Emergency Lane Keeping (ELK) System Emergency Lane Keeping (ELK) System.....	162	5-12. Driver Monitor System (DMS) Driver Monitor System (DMS)	175
5-7. Blind Spot Detection (BSD) System Blind Spot Detection (BSD) System	163	5-13. Parking Assist System Parking View Monitor System (If Equipped)	176
Rear Cross Traffic Alert (- RCTA) System.....	164		

DRIVING ASSIST

Panoramic View Monitor System (If Equipped)	177	Anti-lock Brake System (ABS)	185
Parking Radar System	181	Extended Function	187
5-14. Multi-Collision Brake System (MCB)		5-16. Data Privacy	
Multi-Collision Brake System (MCB)	183	Driver Drowsiness and Attention Warning (DDAW)	187
5-15. Braking Force Control System		Advanced Driver Assistance System (ADAS)	188
Electronic Stability Program System (ESP)	184	Emergency call (eCall)	188

5-1. Speed Limit Assist System (SLA)

Speed Limit Assist System (SLA) (If Equipped)

SLA detects speed limit sign information on road in front and combines the information with speed limit information of navigation system, and use the final speed limit information to remind the driver to pay attention to the various current road speed limit regulations in the form of image, sound, etc., to keep legal speed and observe local traffic laws.

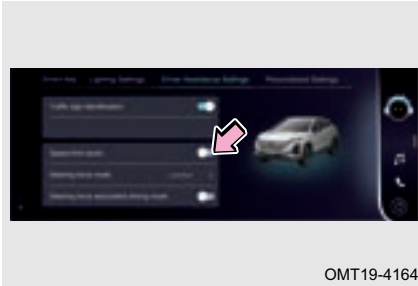

Turn vehicle power to ON mode, turn on the speed limit assist in Audio System - Vehicle Settings - Driver Assistance Settings.

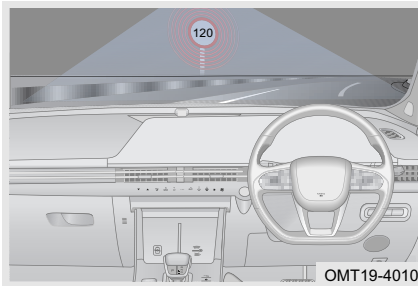

After SLA detects speed limit sign information on road in front and combines the information with speed limit information of navigation system, "120" indicator in instrument cluster remains on, If the speed exceeds the current speed limit, the driver will be alerted by flashing/sounding the speed limit icon.

5. DRIVING ASSIST

Function limit

- SLA may not be able to recognize in following situations:
 - Faded signs.
 - Signs on winding roads.
 - Rotated or damaged signs.
 - High signs on highway.
 - Signs that is covered fully or partly, or that the position can not be found easily.
 - Signs covered by frost, snow, dust fully or partly.

WARNING

SLA based on front view multi-function camera is affected by weather and light, so the function is not appropriate for all conditions.

5-2. Cruise System

Adaptive Cruise Control System (ACC)

ACC can maintain the speed set by driver and can also follow the vehicle at a set safe distance.

Adaptive Cruise Control System (ACC) button

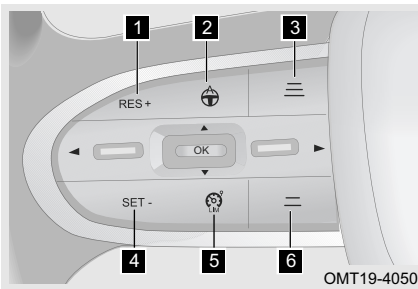

1 "RES+" button: Resume the ACC and adjust speed value.

2 Press: activate / exit ACC or TJA / ICA.

Long press: switch between TJA / ICA and ACC.

3 Vehicle-to-vehicle distance control button: Increase the following distance.

4 "SET-" button: Enter the ACC, ASL and adjust speed value.

5 Active speed limit button: Turn on / off Active Speed Limit (ASL).

6 Vehicle-to-vehicle distance control button: Reduce the following distance.

READ

RES+, SET- are shared button for ACC and ASL.

Adaptive cruise control system (ACC) activation conditions

The following conditions must be met at the same time, ACC can be activated:

- Vehicle speed is higher than 9 mph (15 km/h), or system recognizes a target vehicle ahead.

- Brake pedal is not depressed (during driving).
- Driver door is closed.
- Driver seat belt is fastened.
- Transmission gear position is in D position.
- Parking brake is not applied.
- ESP is turned on.
- ESP is not activated.
- ABS is not activated.
- Bonnet is not opened.
- ASL function turns off.

Usage method

■ Entering ACC

Turn vehicle power to ON mode, the system enter pre-cruising state after activation conditions are met, and "🚗" indicator in instrument cluster remains on:

Method 1: During pre-cruising state, if vehicle speed is higher than 9 mph (15 km/h), press "SET-" button to set current speed as cruise speed and enter cruising state, and "🚗" indicator in instrument cluster remains on; if vehicle speed is less than 9 mph (15 km/h), press "SET-" to set 9 mph (15 km/h) as cruise speed, and "🚗" indicator in instrument cluster remains on.

Method 2: In the current ignition cycle, after ACC exits, press the RES button to set the previous cruise speed as cruise speed and enter the cruising state, and "🚗" indicator in instrument cluster remains on.

5. DRIVING ASSIST

READ

- ACC will exit when the ASL function is turned on. Only after the driver actively turns off the ASL function, ACC can enter the pre-cruising state again when the activation conditions are met.
- ACC is exited when turning on ASL function.
- When there is a vehicle in the front of your vehicle at the same road, and driving speed is no higher than vehicle set speed, ACC will control the vehicle to follow vehicle ahead.
- When there is no vehicle in the front of your vehicle at the same road, or there is a vehicle and driving speed is higher than set vehicle, the vehicle drives at the set speed.
- When applying parking brake and entering pre-cruising state, press "SET-" button, instrument cluster will prompt "Please depress accelerator pedal to activate adaptive cruise control system (ACC)", driver depress accelerator pedal slightly to activate ACC according to the prompt.
- The system may not be available under special conditions (such as desert roads).

■ Exiting adaptive cruise control

When one or more of the following situations occur in cruising process, ACC will exit:

- Depress brake pedal.
- Driver door is opened.
- Driver seat belt is not fastened.
- Apply the parking brake.
- ESP operates.
- ABS operates.
- AEB operates.
- ESP is not turned on.
- Transmission gear position is in a position other than D.
- Driver depress accelerator pedal for more than 15 minutes.
- Press the exit button.
- Bonnet is opened.

After the above conditions that can exit function resume, press "RES+" button, enter cruising state and resume set state before exiting.

■ Speed setting

Press "RES+" button in cruising process, set vehicle speed will increase by 1 mph (1 km/h).

Long press "RES+" button in cruising process, set vehicle speed will increase by 5 mph (5 km/h); when speed exceeds 49 mph (80 km/h), set vehicle speed will increase by 10 mph (10 km/h).

Press "SET-" button in cruising process, set vehicle speed will decrease by 1 mph (1 km/h).

Long press "SET-" button in cruising process, set vehicle speed will decrease by 5 mph (5 km/h); when speed exceeds 49 mph (80 km/h), set vehicle speed will decrease by 10 mph (10 km/h).

READ

- For ACC, the lowest speed setting is 9 mph (15 km/h) and the highest speed setting is 93 mph (150 km/h).
- Speed will be lower than set speed when driving uphill, speed will be higher than set speed slightly when driving downhill.

Following distance

Press the vehicle-to-vehicle distance control button in cruising process, adjust following distance which is divided into five levels. The following time distance are 1.0 s, 1.5 s, 1.9 s, 2.2 s, 2.4 s respectively.

READ

- Following distance changes based on speed and increases with speed improving.
- In minimum clearance mode, the distance between the vehicle and vehicle ahead will be quite small during following at low speed. For safety, select maximum clearance mode to follow vehicle ahead on slippery road.
- During following vehicle ahead and decreasing, ESP continuously performs brake and motor will generate operation sound when rotating, this is normal and please drive at ease.

WARNING

- The driver must control vehicle, operate as needed in the whole driving process to avoid danger.
- Please note that any driver must conform all traffic regulations.

Overtaking

Depress accelerator pedal to overtake set speed in cruising process. After accelerator pedal is released, the control state will return to previous state. During overtaking, if the vehicle is too close to vehicle ahead, instrument cluster will pop up "Please take over the vehicle by driver" accompanied with urgent warning sound to remind driver to avoid.

5. DRIVING ASSIST

Curve speed control

Decrease the speed when vehicle enters curve in cruising process, which help driver to drive through curve safely.

WARNING

- The driver must control vehicle, drive through curve as slowly as possible in the whole driving process.
- While entering a curve, due to limitation of detection target for radar probe, vehicle ahead on the same driving route may not be detected in time, which requires the driver to be ready to take over the control of the vehicle at any time.

Stopping and starting function

During following vehicle ahead in ACC mode, vehicle ahead decreases to stop, the vehicle also decreases to stop, after stopping:

- If vehicle ahead starts within 3 seconds, the vehicle also starts automatically.
- If vehicle ahead stops for more than 3 seconds and starts within 3 seconds to 10 minutes, driver need to depress accelerator pedal slightly to activate ACC.
- When vehicle stops within 10 minutes, driver unfasten seat belt or open driver door, EPB is activated automatically and parking.
- When vehicle stops for more than 10 minutes, the vehicle will exit ACC, and EPB will be activated automatically and parking.

WARNING

While following vehicle ahead, always pay attention to whether indicator "" is green. If it turns to gray, indicating front target has been lost in ACC mode, the vehicle will start to accelerate according to set speed.

Precautions for adaptive cruise control

- ACC has certain limitations. Driver must always keep control of the vehicle and be fully responsible for the vehicle.
- If the vehicle is extremely close to vehicle on adjacent lanes, ACC may select the vehicle as following target.
- ACC can not respond to stationary objects and vehicles, crosswise vehicles, oncoming vehicles, pedestrians, bicycles and animals.
- When stopping vehicle briefly in ACC mode, driver must confirm that there are no obstacles or other traffic participants such as pedestrians, bicycles and animals in front of the vehicle.

- When ACC function is malfunctioning, "🚨!" yellow indicator in instrument cluster comes on. At this time, please go to authorized service centre for inspection and repair as soon as possible.
- During ACC controls vehicle, never inadvertently step on accelerator pedal, otherwise, ACC will not apply brake to vehicle, driver should always be ready to brake actively to ensure the safety of the vehicle.
- ACC has a limited brake time reaction; if vehicle ahead occurs sudden brake, another driver cuts in front of the vehicle, the vehicle cuts behind a preceding vehicle, ACC may not respond or react to vehicle ahead too slow, in this case, driver should take over the vehicle control in time.
- Driver should adjust the following distance from vehicle ahead based on traffic flow and weather condition and is responsible for ensuring the vehicle can stop safely at any time. In inclement weather (rain, snow, fog, etc.), ACC may not recognize a vehicle ahead. In this case, ACC should be turned off.
- ACC is suitable for use on highways and roads in good condition, It is not recommended for use on urban roads, narrow roads, mountain roads, hills, tunnels, etc. If using ACC on curves, target vehicle ahead may be lost or target selection is delayed in ACC mode due to limitation of sensor detection range, in this case, ACC will control vehicle to accelerate to set speed.
- During the process of following the vehicle ahead to stop, ACC may not be able to recognize the end of the vehicle, but the lower or upper part of vehicle (such as rear axle of truck that has higher chassis, upper part of lower flatbed trailer). In these cases, system cannot ensure a proper stopping distance or even lead to collision. Therefore, driver must keep a watch on vehicle and be ready to take over vehicle control anytime during this process.
- Two sensors of radar and camera are installed in the front area of vehicle and behind windshield. Please note that view of sensor should not be covered by debris, and front or surrounding areas should not be modified or decorated with license plate frames, etc. When sensor is completely covered by snow, ACC function will be exited. System performance may be reduced or its function fails due to sensor vibration or collision. In this case, please go to authorized service centre for recalibration of sensors as soon as possible.

Precautions mentioned above do not cover all circumstances that may affect system normal operation. System function may fail to bring the expected effect due to other reasons. Driver must always take full responsibility for vehicle control anytime.

Active Speed Limit



Introduction

Driver drives vehicle at set limit speed.

5. DRIVING ASSIST

Usage method



■ Entering active speed limit



Step 1: Turn vehicle power to ON mode and press " " button to enter pre-speed limit state, and " " indicator in instrument cluster remains on;



Step 2: With engine not started or vehicle speed < 19 mph (30 km/h), press "SET -" button to enter speed limit state, and " " indicator in instrument cluster remains on, default set vehicle speed is 19 mph (30 km/h);

Step 3: In speed limit process, if vehicle speed is within 19-124 mph (30 -200 km/h), press "SET -" button to set current speed as limit speed to enter speed limit state, and " " indicator in instrument cluster remains on.

■ Exiting active speed limit

Press " " button to exit speed limit state, enter pre-cruising state, and " " indicator in instrument cluster remains on.

Press " " button to exit speed limit state, and " " indicator in instrument cluster goes off.

Press the " " to exit speed limit state, enter pre-cruising state, and " " indicator in instrument cluster remains on.

■ Speed setting

Press "RES +" button in speed limit process, set vehicle speed will increase by 1 mph (1 km/h).

Long press " RES + " button in speed limit process, set vehicle speed will increase by 5 mph (5 km/h).

Press "SET -" button in speed limit process, set vehicle speed will decrease by 1 mph (1 km/h).

Long press " SET - " button in speed limit process, set vehicle speed will decrease by 5 mph (5 km/h).

Overtaking

In speed limit process, in order to overtake or in other operation condition, fully depress accelerator pedal to enter pre-speed limit state, and " " indicator in instrument cluster remains on.

After overtaking, if vehicle speed is more than previous set limit speed, it enters pre-speed limit state and " " indicator in instrument cluster remains on.

After overtaking, if vehicle speed is less than previous set limit speed, it enters speed limit state and " " indicator in instrument cluster remains on.

5-3. Hill Descent Control System (HDC)

Hill Descent Control System (HDC) (If Equipped)

Introduction

HDC can help vehicle drive on steep roads safely under controlled conditions. After HDC is turned on, when vehicle is driving down a steep slope, for vehicle with automatic transmission, speed control range is 10 - 21 mph (10 - 35 km/h). When initial speed is lower than the minimum speed, vehicle will control at the minimum speed by default. The current control vehicle speed can be increased or decreased in a given speed range by depressing accelerator or brake pedal.

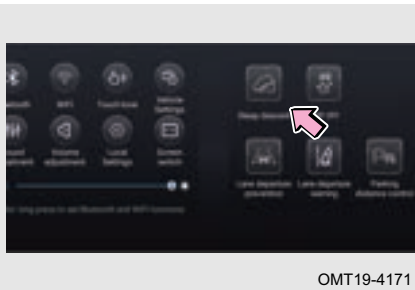
Usage method

OMT19-4171

With vehicle power in ON mode, slide the right edge of the audio main interface to the left to display the shortcut menu interface.

■ Turning on HDC

With vehicle power in ON mode and vehicle speed reaches 37 mph (60 km/h) or less, press HDC switch on the audio system to turn on HDC, and "  " green indicator in instrument cluster remains on.

■ Turning off HDC

With HDC ON and vehicle speed more than 37 mph (60 km/h), press HDC switch on the audio system to turn off HDC, and "  " green indicator in instrument cluster goes off.

 CAUTION

- Before entering steep road, set HDC system so that driver can operate steering wheel without distraction.
- When HDC system is working, the ABS will start automatically if there is a tyre lock.
- When HDC system is working, if any wheel loses contact with ground, the braking force will be distributed to the wheel with higher adhesion coefficient.
- HDC system actively applies the braking force through the ESP work. The system will have a hydraulic operation sound when working, which is normal. When the ESP fails, the HDC function cannot be turned on. Please go to authorized service centre for inspection and repair as soon as possible.

5. DRIVING ASSIST

WARNING

The driver must control vehicle, operate as needed in the whole driving process.

Hill Descent Control (HDC) system indicator

When the system is activated, "" green indicator remains on.

When there is a fault, "" yellow indicator goes off.

5-4. Lane Departure Warning System (LDW)

Lane Departure Warning System (LDW)

LDW detects lane line by front view multi-function camera. The system sends an alarm when wheel rolls over lane line and vehicle departs from its lane.

Introduction

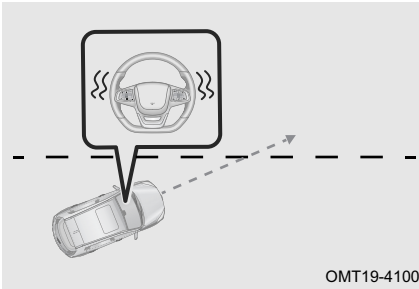

When speed increases to 40 mph (65 km/h) or more, LDW enters activating; When speed decreases from 40mph (65 km/h) to 37 mph (60 km/h), LDW enters pre-activating; When speed is less than 37 mph (60 km/h), LDW exits after 3 seconds.

READ

LDW ON / OFF and sensitivity adjustment can be set in audio system. For details, refer to "Audio System". System will memorize customer operation by default after LDW function is turned on / off by customer.

⚠ CAUTION

- Lane line captured by camera: It can detect white solid line, white dotted line, yellow solid line, yellow dotted line and double solid line lanes.
- The system may not operate in cold and bad weather conditions, rain, snow, fog or strong contrast lighting can affect the sensor.
- The system will only work normally on the roads with two clear lane lines.
- The system may not operate when driving on cement road.
- The system may not operate when driving in road construction area.
- The system may not operate when driving on flooded or muddy roads.
- The system may not work when driving on sharp turns or narrow roads.
- When only single-sided lane line is detected by LDW, the system alarm stability decreases.
- If sensor is disturbed, the system may not work.
- Sensors may misidentify temporary construction markings on the road, etc. and give false alarm by mistake.
- If your vehicle suspension kit is not approved by us, LDW may not work properly.
- Keep front view multi-function camera free from obstructions, such as bird droppings, insects and ice.

⚠ WARNING

- Lane assist system just offers assistance to you. It may not work properly under all driving conditions, weather conditions, traffic conditions or road conditions.
- The driver must control vehicle, operate as needed in the whole driving process.

Lane departure warning system (LDW) indicator

When LDW enters pre-activating mode, " " gray indicator in instrument cluster remains on.

When LDW enters activating mode, " " green indicator in instrument cluster remains on.

When LDW operates, " " green indicator in instrument cluster blinks.

When LDW is malfunctioning, " " yellow indicator in instrument cluster remains on.

Function limit

LDW may not work properly in the following conditions:

- When changing lanes.
- When turning with high speed.

5. DRIVING ASSIST

- When depressing accelerator pedal with excess force.
- When depressing brake pedal with excess force.
- When turning on hazard warning light.
- When turning on departure side indicator light.
- When driving on roads with tight curves.
- When lane line is too thin, broken, blurred or departure side has no lane line.

5-5. Lane Departure Prevention System (LDP)

Lane Departure Prevention System (LDP)

Introduction

The system monitors the relative position of the vehicle and the lane sideline in real time, controls the lateral movement of the vehicle when the vehicle is about to deviate from the lane, and assists the driver to keep the vehicle in the original lane.

Activating LDP

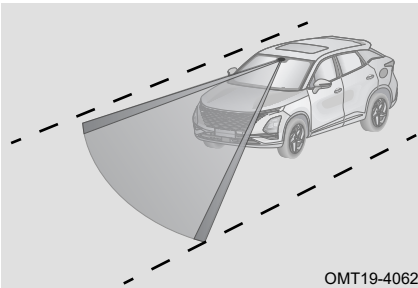

When lane departure prevention system is turned on, speed increases to 40 mph (65 km/h) or more and the vehicle deviates from one lane line, LDP is activated. When speed decreases from more than 40 mph (65 km/h) to 37 mph (60 km/h), LDP is restrained.

READ

LDP ON / OFF can be set in audio system. For details, refer to "Audio System".

CAUTION

- Driver performs an active control when meeting a tighter curve.
- Driver performs an active control when meeting some conditions such as lane increase, lane merger, etc.
- Driver performs an active control when meeting complex traffic environment (such as intersection, heavy traffic road).

Lane departure prevention system (LDP) indicator

When the system is on or restrained, "" gray indicator in instrument cluster remains on.

When the system is pre-activated or activated, " " green indicator remains on.

When there is a fault, " " yellow indicator in instrument cluster remains on.

Function limit

■ LDP may not work properly in the following conditions:

- When changing lanes.
- When turning on directional indicator lights.
- When braking with excess force.
- When steering angle speed is too high.
- When depressing accelerator pedal with excess force.
- When turning on hazard light.
- LDP can recognize when the driver does not operate steering wheel for a while.
- Steering wheel is operated by driver when LDP applies corrective steering intervention.

■ Under the following situations, do not use LDP. Failure to do so may cause an accident, resulting in death or serious injury:

- If sensor is disturbed, the system may not function.
- The system can operate only when vehicle speed is more than 40mph (65 km/h).
- Lane departure prevention system may not operate when driving in road construction area.
- Lane departure prevention system may not operate when driving on flooded or muddy roads.
- Lane departure prevention system may not operate when driving on sharp turns or narrow roads.
- Lane departure prevention system can only operate normally on the roads with two clear lane lines.
- If your vehicle suspension kit is not approved by us, the system may not work properly.
- Sensors may misidentify temporary construction markings on the road, etc. and give false alarm by mistake.
- The system may not operate in cold and bad weather conditions, rain, snow, fog or strong contrast lighting can affect the sensor.

5. DRIVING ASSIST

5-6. Emergency Lane Keeping (ELK) System

Emergency Lane Keeping (ELK) System

When the vehicle deviates from the edge of road, an oncoming vehicle in an adjacent lane or an overtaking vehicle in an adjacent lane, the system automatically corrects the vehicle's direction to improve driving safety.

Operating instructions

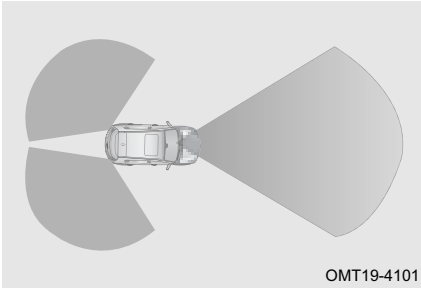

The system is on when the speed reaches 40 mph (65 km/h). After the function is activated, when the speed is decreases from 40 mph (65 km/h) to 37 mph (60 km/h) or less, ELK is restrained.

READ

Emergency Lane Keeping (ELK) ON / OFF can be set in audio system. For details, refer to "Audio System".

Function limit

■ Under the following situations, the system may not correctly identify traffic conditions:

- On winding mountain roads.
- In severe weather conditions.
- There are some special buildings on the roadside (such as high or scattered road guardrail).
- When rain, snow, ice, fog or dust blocks the sensor.
- Narrow objects such as bicycles may not be recognized.
- Lane departure prevention system can only operate normally on the roads with two clear lane lines.
- If your vehicle suspension kit is not approved by us, the system may not work properly.
- Sensors may misidentify temporary construction markings on the road, etc. and give false alarm by mistake.
- The system may not operate in cold and bad weather conditions such as rain, snow or fog and strong contrast lighting can affect the sensor.

⚠ WARNING

- Never use a system that is not properly calibrated.
- To ensure the safety of driving and riding, all the passengers must wear seat belts.
- If the sensor is blocked, the system cannot be operated. Clear the sensor where possible.
- This system is only a driving assistance system, do not rely solely on this system and drive carefully at all times.
- To ensure the normal operation of the system, it is necessary to keep the sensors in the bumper clean, free of snow and ice, and not covered by other objects.
- If this system does not work properly, turn off the system immediately, please go to authorized service centre for inspection and repair as soon as possible.

5-7. Blind Spot Detection (BSD) System**Blind Spot Detection (BSD) System**

BSD system is used to monitor presence of moving vehicles in left and right rear areas of your vehicle and inform driver related information to remind the driver for driving safety and lane-changing safety. This system extends Lane Change Assist (LCA) system and Rear Cross Traffic Alert (RCTA) system, Rear Cross Traffic Braking (RCTB) system etc.

⚠ WARNING

The BDS system only offers assistance to the driver. It may not work properly under all driving conditions, weather conditions, traffic conditions or road conditions.

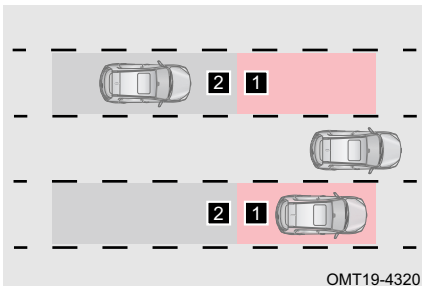
Activating Blind Spot Detection (BSD) system / Lane Change Assist (LCA) system

When speed increases to 9 mph (15 km/h) or more, BSD system enters activating; When speed is decreases from more than 9 mph (15 km/h) to 6 mph (10 km/h), BSD system enters pre-activating.

- 1** Detection area of BSD system.
- 2** Vehicle approaches detection area of BSD system.

5. DRIVING ASSIST

Level I: If a vehicle enters detection area and meets alarm conditions, level alarm I is triggered. "BSD" yellow indicator on rear view mirror remains on, "BSD" green indicator in instrument cluster remains on.

Level II: On base of level I, turn on the indicator light in the same side. After level alarm II is triggered, "BSD" yellow indicator on rear view mirror blinks, "BSD" yellow indicator in instrument cluster blinks, alarm sounds.

READ

- BSD can be set in audio system. For details, refer to "Audio System".
- Turn vehicle power to ON mode, BSD system turns on by default.

CAUTION

- Blind Spot Detection (BSD) system may detect stationary objects on or near a road (such as guardrails, tunnels, side walls, and parked vehicles) to turn on warning light.
- When towing or attaching accessories to rear of vehicle (such as a bicycle carrier), turn off BSD system. Otherwise, radar radio waves will be affected, causing system work abnormally.
- When lots of snow or ice accumulates on rear bumper and near radar sensor, or if drive on snowy road for a long time, BSD system may not work.

Blind Spot Detection (BSD) system indicator

During operation, level alarm I "BSD" green indicator in instrument cluster remains on; level alarm II "BSD" yellow indicator in instrument cluster blinks.

When there is a fault, "BSD" yellow indicator in instrument cluster remains on.

Rear Cross Traffic Alert (RCTA) System

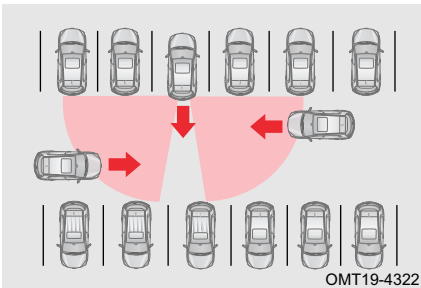

When vehicle power is turned to ON mode and vehicle is backed up (shift lever is in R position), BSD system detects that vehicles are approaching from left / right sides, "BSD" yellow indicator on rear view mirror blinks and alarm sounds.

Rear Cross Traffic Braking (RCTB) System (If Equipped)

RCTB function sounds alarm to driver and assists in braking when encountering vehicles or pedestrians crossing the road when exiting a vertical/inclined parking space. RCTB function can help driver avoid collisions with

vehicles or pedestrians crossing the road, especially if the driver's view is blocked by vehicles parked next to them.

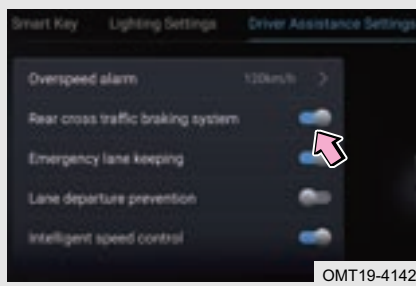

Turn vehicle power to ON mode, turn on rear cross traffic braking system in Audio System - Vehicle Settings - Driver Assistance Settings.

Activation conditions for RCTB

- All doors are closed.
- Steering wheel angle is less than the threshold.
- Vehicle speed is lower than 9 mph (15 km/h).
- Vehicle is in reverse gear.

WARNING

- RCTB is a driving assistance function, which has certain limitations. Driver must always keep control of the vehicle and be fully responsible for the vehicle.
- Certain scenarios will affect and weaken the detection of sensor, the system may perform unnecessary warning and braking, or fail to detect all obstacles.
- The area around sensor must not be modified in any way, it is recommended to turn off rear cross traffic braking system after modification, otherwise the system may perform brake unnecessarily.

5. DRIVING ASSIST

5-8. Automatic Emergency Braking System (AEB) / Front Collision Warning System (FCW)

Automatic Emergency Braking System (AEB) / Front Collision Warning System (FCW)

When vehicle is about to hit a vehicle or pedestrian ahead, AEB and FCW work together, sounding an alarm to remind driver, if driver cannot respond quickly enough, vehicle will brake automatically, reducing loss from collision.

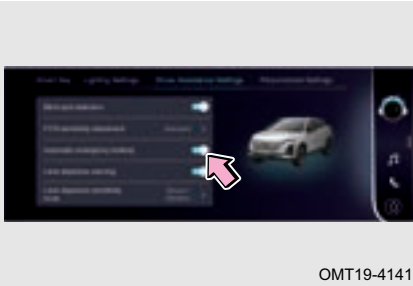

Turn vehicle power to ON mode, and turn on the AEB/FCW in Audio System - Vehicle Settings - Driver Assistance Settings.

Activating AEB / FCW

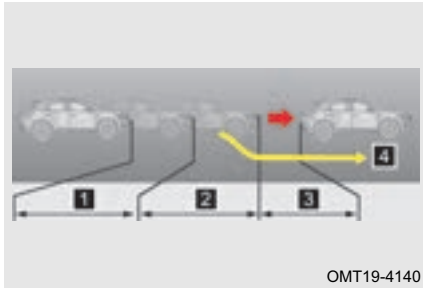

- 1** Start pre-warning before impacting.
- 2** Start braking partly before impacting.
- 3** Start emergency braking before impacting.
- 4** If driver reacts correctly (for example, avoid a collision by steering), the following emergency braking is canceled.

READ

- Some configurations operate only for the vehicles, not for pedestrians and cyclists.
- If the system detects that a collision is about to occur after 2.5 s during vehicle driving, FCW will start warning.

 CAUTION

- When speed is less than 18 mph (30 km/h), FCW does not sound an alarm; When speed is more than 52 mph (85 km/h), FCW does not sound an alarm for static target ahead.
- Operating speed range of AEB is 2 - 38 mph (4 - 62 km/h) (some models are 2 - 29 mph (4 - 48 km/h)) for static vehicle target; Operating speed range of AEB is 2 - 52 mph (4 - 85 km/h) for moving vehicle target; Operating speed range of AEB is 2 - 40 mph (4 - 65 km/h) for pedestrians and cyclists (some models do not support).
- Driver need to ensure that seat belts have been fastened, doors are closed. Failure to do so, AEB does not work.
- Turn on ESP, FCW, AEB, otherwise, FCW and AEB do not work.
- " " yellow indicator in instrument cluster remains on, please go to authorized service centre for inspection and repair as soon as possible.
- Driver need to take over vehicle because vehicle does not keep stationary state when vehicle is braked automatically to stopped.
- During AEB is activated, driver quickly rotates steering wheel or depresses accelerator pedal firmly, AEB will exit.
- The system may not be available under special conditions (such as desert roads).

 WARNING

- The driver must control vehicle and operate as needed during the whole driving process to avoid danger.
- AEB only offers assistance to the driver. It may not work properly under all driving conditions, weather conditions, traffic conditions or road conditions.
- The vehicles that can be detected by AEB include passenger vehicles, buses, trucks. For some vehicles, such as such as cement tank trucks, special vehicles with higher or lower chassis, AEB has certain limitations in detecting.
- Automatic emergency braking system (AEB) can only play its best role when it detects characteristics consistent with normal walking, such as person's head, arm swing, leg swing, etc.
- AEB will work when it detects body and bicycle contour information as well as normal cycling movements; AEB does not detect an oncoming cyclist as target.
- AEB is not always capable of detecting vehicles, cyclists or pedestrians, and the system may generate unnecessary braking automatically or do not work for a variety of reasons; AEB is only a driving assist system to reduce severity of collision, it is not always possible to completely avoid collision in the speed range.

5. DRIVING ASSIST

Precautions for automatic emergency braking system (AEB)

- AEB has certain limitations. Driver must always keep control of the vehicle and be fully responsible for the vehicle.
- Driver controls speed and the distance from vehicle ahead according to weathers, road surface conditions, traffic conditions, etc.
- AEB does not react to animals, crossing vehicles, incoming vehicles, bicycles and pedestrians.
- System performance may be greatly limited for obstacles that cut into the lane quickly, obstacles that are detected after the vehicle changes lanes, and obstacles in curves.
- Fasten all seat belts and secure all loads to avoid danger when AEB is triggered.
- When AEB is malfunctioning, "🚨" yellow indicator in instrument cluster remains on, please go to authorized service centre for inspection and repair as soon as possible.
- When inspecting the vehicle using a drum tester, FCW and AEB should be turned off.
- When installing non-full size spare tyre, it is recommended that customer turns off FCW and AEB, and replace full-size tyres of original vehicle in time.
- In some special circumstances, AEB may perform unnecessary warning and braking, such as crossing the track of the road, entering an underground car park turning, etc. Some circumstances will affect and weaken sensor detection, things like a tunnel, light of incoming vehicle, reflection of slippery road.
- Two sensors of radar and camera are installed in the front area of vehicle and behind windshield; Please note that view of sensor should not be covered by pollutants, and front or surrounding areas should not be modified or decorated with license plate frames, etc. Especially, when sensor is completely covered by snow, system function will be exited. AEB performance may be reduced or it's function fails due to sensor vibration or collision. In this case, please go to authorized service centre for recalibration for sensors as soon as possible.

Precautions mentioned above do not cover all circumstances that may affect AEB normal operation. AEB function may fail to bring the expected effect due to other reasons. Driver must always assume full responsibility for vehicle control anytime.

5-9. Traffic Jam Assist System (TJA) / Integrated Cruise Assist System (ICA)

Traffic Jam Assist System (TJA) / Integrated Cruise Assist System (ICA)

Introduction

TJA / ICA detects lane line through the front view camera to perform vertical and horizontal control for vehicle, providing driving assist and reducing driver's workload under monotonous driving environment or busy traffic.

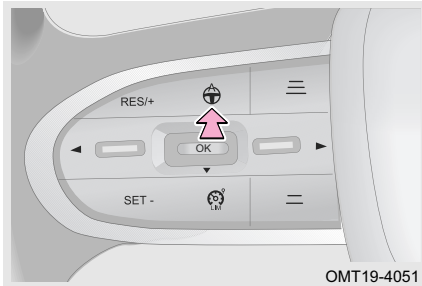

Activate/deactivate function: When TJA/ICA is in pre-activating or activating state, short press TJA/ICA switch to activate/deactivate TJA/ICA.

Mode switching function: When ACC is in pre-cruising or cruising state, or when TJA/ICA is in pre-activating or activating state, long press TJA/ICA switch to switch between ACC and TJA/ICA modes.

If the TJA/ICA activation conditions are not met at this time, the "⊖" gray indicator on instrument cluster remains on; if the TJA/ICA activation conditions are met at this time, the "⊕" green indicator on instrument cluster remains on.

TJA is used when speed is less than 37 mph (60 km/h): Vehicle will be kept near lane center. If no lane line is detected, the vehicle follows vehicle ahead as driving target. If neither lane line nor target vehicle is detected, TJA will be turned off.

ICA is used when speed is 37 mph (60 km/h) to 80 mph (130 km/h): Vehicle will be kept near lane center. If no lane line is detected, ICA will be turned off regardless of whether there is a target vehicle ahead.

Traffic Jam Assist System (TJA)/Integrated Cruise Assist System (ICA) Indicator

When it is pre-activated, "⊖" gray indicator on instrument cluster remains on.

When it is activated, "⊕" green indicator on instrument cluster remains on.

When there is a fault, "⊕" yellow indicator on instrument cluster remains on.

Function limit

TJA / ICA may not work properly in the following conditions:

- Any exiting condition for ACC exists.
- Overly narrow or wide lanes.
- Too small lane curve radius.
- Lane line is not detected.

5. DRIVING ASSIST

- Driver rotates steering wheel actively.
- Hands off steering wheel.
- Directional indicator lights are turned on.
- Hazard warning light is turned on.
- Vehicle speed is less than 1 mph (1 km/h).

WARNING

- TJA / ICA just offers assistance to you. It may not work properly under some driving conditions, weather conditions, traffic conditions or road conditions.
- The driver must control vehicle, operate as needed in the whole driving process.
- The system may not be available under special conditions (such as desert roads).

Recommended to use Traffic Jam Assist System (TJA)/Integrated Cruise Assist System (ICA)

When the Traffic Jam Assist system (TJA)/Integrated Cruise Assist system (ICA) monitors that the vehicle speed is higher than 37 mph (60 km/h), the current road line is clear and continues to exist, and the Adaptive Cruise Control system (ACC) is in cruising state, the "  " green indicator on instrument cluster remains on. After a certain period of time, a pop-up screen on instrument cluster prompts "The road conditions are good, it is recommended to turn on intelligent cruise control".

Traffic Jam Assist System (TJA)/Integrated Cruise Assist System (ICA) Exit Reminder

When TJA/ICA exits from activating state, the system sends an alarm sound and a pop-up screen on instrument cluster prompts "Intelligent cruise control has exited, please pay attention" to inform the driver that the function has exited.

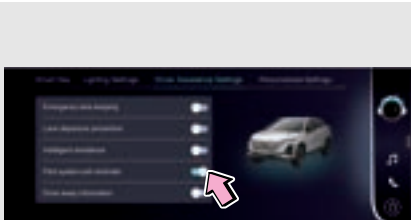

OMT19-4174

Turn vehicle power to ON mode, and turn on the intelligent cruise control exit reminder in Audio System - Vehicle Settings - Driver Assistance Settings.

If you feel that the exit reminder will interfere with driving, you can turn off this reminder according to your preference.

Precautions for traffic jam assist system (TJA) / integrated cruise assist system (ICA)

For using TJA / ICA, please read the following precautions carefully:

- TJA / ICA is a driving assist system, has certain limitations. Driver must always keep control of the vehicle and be fully responsible for the vehicle.
- Longitudinal control of TJA / ICA is performed by ACC, lateral control of TJA / ICA is performed by LKA, all precautions for ACC and LKA are also applicable to the system.
- TJA / ICA does not provide automatic driving function and does not allow hand off driving. Driver prepares control vehicle anytime to ensure safety under the conditions of turning, crossing, merging into one lane and vehicle ahead becoming an obstacle to progress.
- TJA / ICA performance is affected by weather, illumination and lane line definition, with significant performance degradation or even loss of function in the case of backlight, sunset, nighttime, road surface covered by snow and ice, and unclear lane lines due to surface worn.
- When TJA / ICA is malfunctioning, "⚠" yellow indicator in instrument cluster comes on, at this time, TJA / ICA function fails, please go to authorized service centre for inspection and repair as soon as possible.

Precautions mentioned above do not cover all circumstances that may affect system normal operation. System function may fail to bring the expected effect due to other reasons. Driver must always assume full responsibility for vehicle control anytime.

Intelligent Avoidance System

Introduction

Under active control of Traffic Jam Assist System (TJA) / Integrated Cruise Assist System (ICA) (i. e. driving in the lane), when the vehicle speed is 37 mph (60 km/h) to 80 mph (130 km/h) and is about to overtake a larger vehicle (such as a truck, bus) in the adjacent lane, the system controls the vehicle to move laterally appropriately to keep it away from the large vehicle until overtaking is completed.

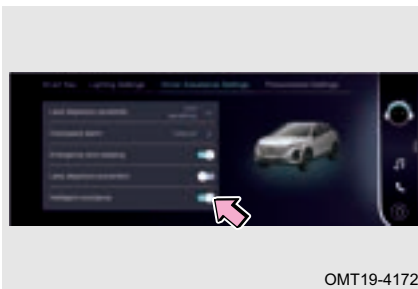

Turn the vehicle power to ON mode, and turn on intelligent avoidance system in Audio System - Vehicle Settings - Driver Assistance Settings.

5. DRIVING ASSIST

5-10. Drive Away Information System

Drive Away Information System

Introduction

Drive away information system allows user to relax and focus on other things other than driving when the vehicle is in line at traffic light-controlled intersections or congested roads, and assists the driver to resume driving in time when the traffic environment changes.

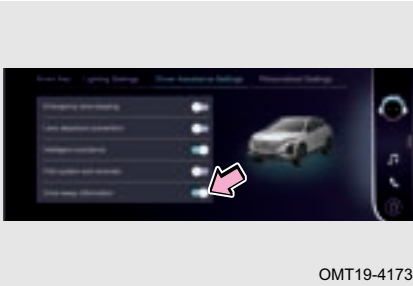

Turn the vehicle power to ON mode, and turn on drive away information system in Audio System - Vehicle Settings - Driver Assistance Settings.

■ If the vehicle is waiting in line at traffic light-controlled intersections or congested roads, when the following conditions are met, the system will sound an alarm and instrument cluster will display that the vehicle ahead is moving, which can remind the driver to resume driving:

- Detect that a vehicle ahead is leaving.
- The vehicle is stationary.
- ACC is not activated.

READ

When the vehicle is waiting in line, if another vehicle gets between the vehicle and the vehicle ahead, drive away information system abandons the original vehicle target and selects the new vehicle as the new target.

5-11. Tyre Pressure Monitoring System (TPMS)

Tyre Pressure Monitoring System (TPMS)

Introduction

TPMS is an active safety configuration and can monitor pressure and temperature of tyre in real-time and the information can be checked through information display area. When tyre pressure is too low or temperature is too high, tyre pressure monitoring system alarms.



Steering wheel left combination button " ◀ " / right combination button " ▶ " can be used to switch to tyre pressure display screen.

When vehicle power is turned to ON mode, tyre pressure and temperature values will be displayed on instrument cluster.

When speed is more than 15 mph (25 km/h) for period of time, tyre pressure and temperature values will be displayed on instrument cluster in real-time; Vehicle power is turned from OFF mode to ON mode (without power-off), tyre pressure and temperature values will also be displayed on instrument cluster.

When speed is more than 15 mph (25 km/h), if TPMS has not received radio-frequency signal from one or more sensors after several minutes, system malfunction warning. "⚠" yellow indicator on instrument cluster will come on.

READ

Common radio interference sources include vehicle power, driving recorder, air purifier, entrance guard card, remote control, cell phone base station, TV tower, etc.

Low pressure warning



When vehicle power is in ON mode, and tyre pressure is less than low alarm threshold, system will warn for low pressure. During low pressure warning, corresponding wheel icon and current tyre pressure value will be displayed in red and "⚠" yellow indicator in instrument cluster remains on.

When low pressure warning occurs, please inflate the tyre to specified value as soon as possible. After the vehicle is driven for a period of time at a speed greater than 15 mph (25 km/h), low pressure warning cancels automatically.

READ

- Low tyre pressure will increase fuel consumption and aggravate tyre wear. Serious tyre wear may cause a risk of tyre blowout.
- When tyre pressure is too low, inspect causes of air leakage. Contact the authorized service centre for inspection and repair as soon as possible as needed.

5. DRIVING ASSIST

High temperature warning



When vehicle power is turned to ON from OFF, and tyre temperature is higher than 85°C, system will warn for high temperature. During high temperature warning, corresponding wheel icon and current tyre temperature value will be displayed in red and "!" yellow indicator in instrument cluster remains on.

When warning for high temperature is activated, if tyre temperature is $< 80^{\circ}\text{C}$, high temperature warning cancels automatically.

CAUTION

- When warning for high temperature, stop driving at once to cool down tyres naturally. Otherwise, accidents may be caused.
- When tyre temperature is too high, it cannot be cooled by pouring cold water, as this may damage the tyre, causing an accident.
- When tyre temperature is too high, please contact the authorized service centre for inspection and repair as soon as possible as needed.

Function limit

TPMS may send system malfunction warning in the following conditions:

- Configuration learning of tyre pressure monitoring system is not performed after replacing wheels (spare tyre included).
- Sensor may be affected due to electromagnetic shielding caused by installing tyre chains, affecting proper operation of TPMS.
- Tyre pressure sensor or other components have been damaged, please contact the authorized service centre for inspection and repair as soon as possible as needed.
- TPMS may not operate due to radio interference; And it may be interfered temporarily due to strong electromagnetic radio signals with same frequency (433 MHz).
- TPMS may not work properly due to interference of electronic equipment (-over standard equipment) installed on vehicle, resulting false alarm.

5-12. Driver Monitor System (DMS)

Driver Monitor System (DMS)

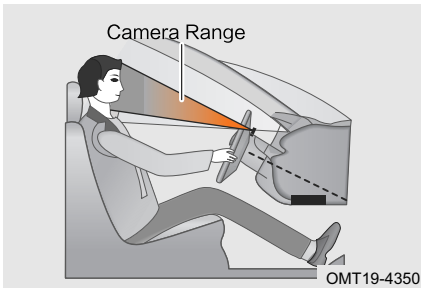

Driver monitor system is on by default.

Driver monitor system uses the infrared camera arranged on the steering wheel to monitor and collect the face image of driver (such as yawning, eyes closed, nodding, etc.) and line-of-sight area information in real time, and collect and judge the driver status in real time.

Driver monitor system indicator

- When driver monitor system is activated, "👁️" indicator on the meter comes on
- When driver monitor system is abnormal, "🚨" indicator on the meter comes on. Please go to authorized service centre for inspection and repair as soon as possible.

Fatigue Monitoring

- Determine if driver is fatigued by monitoring facial expression, eye closure, blinking frequency, etc. of driver.
- Improve driver fatigue state through a certain interactive method; automatically search the nearest service area and navigate.

Distraction Monitoring (Gaze Tracking)

Determine driver gaze area and of it is distracted driving by tracking driver gaze.

 **READ**

- DMS can be set in audio system. For details, refer to "Audio System".
- When the vehicle speed is higher than 6 mph (10 km/h), driver monitor system will sound an alarm when the system detects that driver is in a fatigued driving state.
- When the vehicle speed is greater than 12 mph (20 km/h), driver monitor system will sound an alarm when the system detects that driver is distracted or does not respond to the reminder.

 **CAUTION**

- Do not use abrasive or sharp objects to clean the camera.
- Please check that the camera is clean and free of obstructions to ensure that the system works properly.

5. DRIVING ASSIST

WARNING

Driver monitor system just offers assistance to you. In any case, the driver should be responsible for the safety of the vehicle. Fatigue and distracted driving are strictly prohibited. He/she must always concentrate on driving carefully.

5-13. Parking Assist System

Parking View Monitor System (If Equipped)

Introduction

Parking view monitor system collects the rear view image of vehicle through rear camera and displays the rear view and lane guideline by audio head unit, providing safety and easy parking for driver.

Note: Please refer to the actual vehicle for all display images.

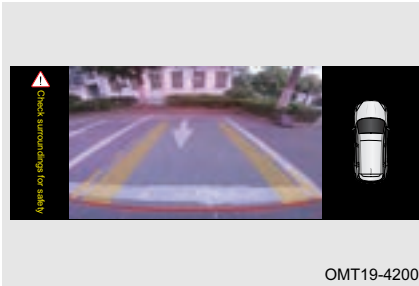

Move shift lever to R to enter parking view monitor screen, and the screen will display the parking view monitor and lane guideline. Lane guideline varies depending on steering wheel rotation and it is used for prejudging the reversing traveling trajectory.

CAUTION

- Use the distance as a reference (such as on the hill).
- Vehicle width guideline and predicting line are wider than the actual line.
- Do not scratch the lens when cleaning dirt or snow on the camera surface.
- If tyre is replaced with a different size, the displayed predicting line is different from the actual line, please use the rear view mirror or check and determine distance to other objects actually.

⚠ WARNING

- When reversing, make sure that boot door is firmly closed.
- Due to the limited monitoring range, parking view monitor system cannot view the bottom and corners of bumper.
- Because rear camera use wide-angle lens, object distance displayed on parking view monitor may appear different from the actual distance.
- Parking view monitor is convenient, but it is not a substitute for correct reverse operation. When reversing, be sure to look around to check if the surrounding is safe and reverse slowly.
- When washing the vehicle body with high-pressure water, do not spray water around the camera, otherwise, water will enter camera and condense on the lens, causing malfunction, fire, or electric shock.
- Never hit the lens. It is a precise instrument. Hitting the lens may lead to malfunction or damage, causing a fire or electric shock.
- Rear camera lens may enlarge and distort the view, so image on display is different from real object or it cannot reflect the real object accurately, and there is also blind spot and a little delay.
- When reversing, always pay extra attention to surrounding children, small animals and objects, because they cannot always be detected by camera.
- Never distract your attention from surrounding traffic due to images on display.

Panoramic View Monitor System (If Equipped)**Introduction**

Panoramic view monitor system collects the surrounding view image of the vehicle through four cameras and displays the surrounding view via audio head unit, providing safety and easy parking for driver.

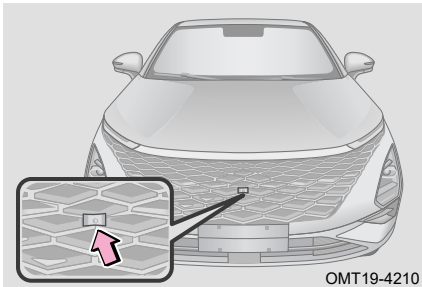
Camera layout

Installation position of front camera: located at intake grille of front bumper.

5. DRIVING ASSIST

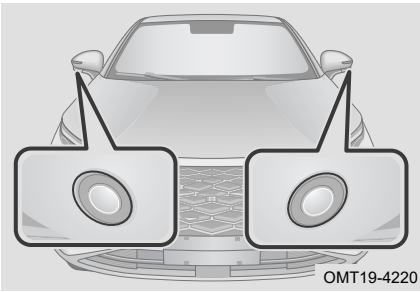

Installation position of left / right cameras: located at the bottom of left / right outside rear view mirrors.

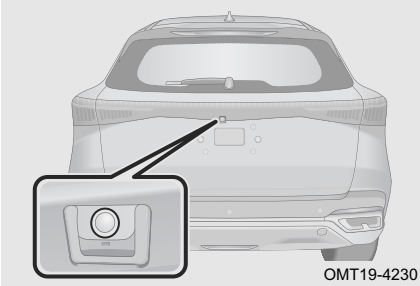

Installation position of rear camera: located at center part above rear license plate.

Usage method

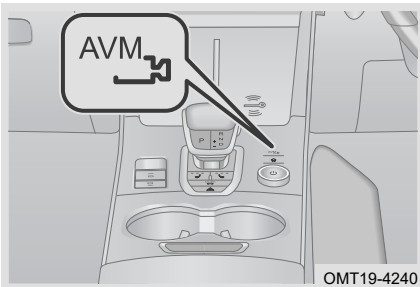

- Entering panoramic view monitor
Turn vehicle power to ON mode, and vehicle speed is 12 mph (20 km/h) or less:
Shift the shift lever to R position to enter panoramic view monitor system.
Press panoramic view monitor switch to enter panoramic view monitor system.

It enters panoramic view monitor system when turning with large angle (it is necessary to activate panoramic view monitor when turning in panoramic view monitor setting).

It enters panoramic view monitor system when turning on left / right indicator lights (it is necessary to turn on activate panoramic view monitor when operating indicator lights in panoramic view monitor setting).

■ Exiting panoramic view monitor

When speed is more than 18 mph (30 km/h), it exits the panoramic view monitor system.

After turning vehicle power to OFF mode, it exits the panoramic view monitor system.

When panoramic view monitor system is entered by receiving parking radar obstacle distance signal, move shift lever to N / P position or there is no obstacle distance information, after delaying 15 seconds, it exits the panoramic view monitor system.

When panoramic view monitor system is entered by R position, move shift lever out from R position to exit the panoramic view monitor system after delaying 15 seconds.

When panoramic view monitor system is entered by panoramic view monitor switch, click the switch again to exit the panoramic view monitor system.

When panoramic view monitor system is entered by left / right indicator signal lights, turn off left / right indicator signal lights to exit the panoramic view monitor system.

CAUTION

The panoramic view monitor system provides driver assistance convenience, but the object in the image does not reflect the actual size and obstacle distance. Compared to the actual image, the image has a little delay and blind spot. Therefore, the panoramic view function is not a substitute for driver's operation and judgment. Driver should pay attention to the surroundings and drive safely during turning on / off and using the function.

Switching view

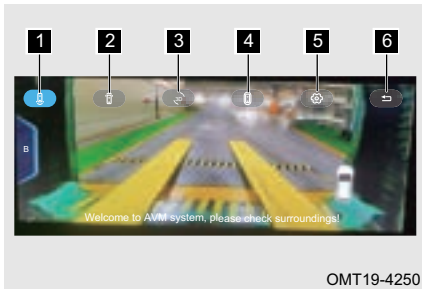

1 Rear wide angle view button

Perform distortion correction on rear views and splice them into a wide angle view.

2 Front wide angle view button

Perform distortion correction on front views and splice them into a wide angle view.

3 3D view + birds-eye view button

Click the specific view angle button around the bird's-eye view of vehicle to switch the corresponding 3D view. 3D view can be switched to any view angle by sliding.

4 Unilateral + birds-eye view button

Unilateral view of front / rear / left / right + splicing view and unilateral view can be switched.

5 Setting button

Click to pop up the setting item menu.

5. DRIVING ASSIST

6 Back button

When gear position is not in R, it is possible to exit panoramic view monitor system using back button.

Note: Please refer to the actual vehicle for all display images.

READ

The panoramic view monitor system is very helpful for parking and safety driving. It is recommended that you should be familiar with this function in advance in an open and convenient area.

CAUTION

- Do not scratch the lens when cleaning dirt or snow on the camera surface.
- Before using panoramic view monitor system, make sure to extend outside rear view mirrors and close the boot door firmly.
- The object distance seen from the panoramic view monitor system is different from the actual distance.
- Do not place any object on the camera of panoramic view monitor system.
- The panoramic view monitor system has been calibrated professionally before leaving the factory. Any removal / installation and changes on camera installation position and angle without permission may affect the function and effect of panoramic view monitor system.
- The panoramic view monitor system provides driving assistance convenience, but the object in the image does not reflect the actual size and obstacle distance. Comparing with the actual image, the image has a little delay and blind spot. Therefore, the panoramic view function is not a substitute for driver's operation and judgment. Driver should pay attention to the surroundings and drive safely during turning on / off and using the function.

System setting

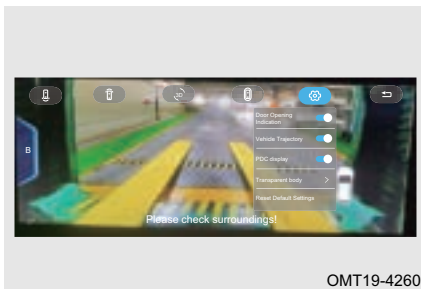

[AVM Start Animation]: When driver enters the panoramic view monitor system for the first time by panoramic view monitor button, panoramic view starting screen will be displayed.

[AVM Activation From Turn Light]: When left / right indicator signal light switch is turned on, 3D view of rear left side or rear right side of vehicle will be displayed.

[AVM Activation From Steering Angle]: When steering wheel angle is more than 190°, 3D view of rear left side or rear right side of vehicle will be displayed.

[Auto Nearby View]: Enter nearby view automatically based on obstacle distance.

[Door Opening Indication]: Remind the status of engine compartment, moon roof, four doors and luggage compartment.

[Vehicle Trajectory]: Move shift lever to R to enter panoramic view monitor, load static / dynamic lane guideline and wheel track line.

[PDC display]: Turn on parking radar display.

[Transparent body]: Set transparency of the vehicle model.

[Reset Default Settings]: Reset default settings.

Parking Radar System

Introduction

Parking radar system is a radar detection device, adopts 6 radar sensors to detect if there are obstacles in front / rear of vehicle and distance from obstacles. The driver is prompted by the audio system, sound alarm, etc., so as to assist the driver to park safely and easily.

Usage method

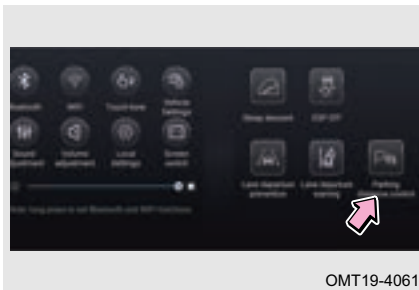

Turn vehicle power to ON mode, press parking radar switch or shift lever is moved to R position, parking radar system is activated, each time the parking radar system is activated, if the parking radar system is normal, it alarms for 0.5 s, parking radar system status indicator comes on and system starts detecting distance at the same time; When a radar sensor detects an obstacle, audio system will read unit displays distance from obstacle (red, yellow, green areas) accompanied by alarm sound.

When vehicle is traveling forward and the reversing radar system is activated, when vehicle speed is > 9 mph (15 km/h), the reversing radar system front and rear sensors stop working. If vehicle speed is < 9 mph (15 km/h), the parking radar system does not recover, the parking radar system can be turned on / off by pressing parking radar switch.

Note: If there are malfunctions in parking radar system, it will sound 2s in long tone, and then keep displaying failure information until it is solved.

5. DRIVING ASSIST

READ

- Monitoring distance is the shortest vertical distance between obstacle and radar sensor.
- Under activating state of front radar, when applying parking brake or shift lever is in P position, audio head unit will only display arc information, and audio head unit prompt does not sound.
- Move shift lever to R position to activate parking radar system (whether or not parking radar system is turned on before moving shift lever to R position), parking radar system still operates when shifting to other positions.

CAUTION

- For obstacles out of the detection range, radar sensors do not give a warning.
- When moving, be aware that the reverse radar sensors on the other side may get close to other obstacles.

Function limit

Parking radar system may not work normally in the following conditions:

- When vehicle is on a steep slope.
- When driving in snow or in rain.
- Low objects such as rocks, etc. cannot be detected.
- Objects that are higher than bumper cannot be detected.
- Thin objects such as wires, fences and ropes, etc. cannot be detected.
- When vehicle is equipped with a high frequency radio or antenna is in use.
- When radar sensor surfaces are frozen, they will not detect any obstacle.
- When radar sensors are covered by dirt, snow or mud, they may not detect obstacles.
- Objects that easily absorb ultrasonic waves such as soft snow, cotton, sponge, etc. cannot be detected.
- When there is noise near the vehicle, such as vehicle horns, motorcycle engines, air brakes of large vehicles, or other loud noises producing ultrasonic waves.
- If obstacles are detected by multiple radar sensors, the distances between each radar sensor and obstacles are displayed on audio head unit simultaneously, and system sounds according to nearest obstacle.

Cleaning radar sensor

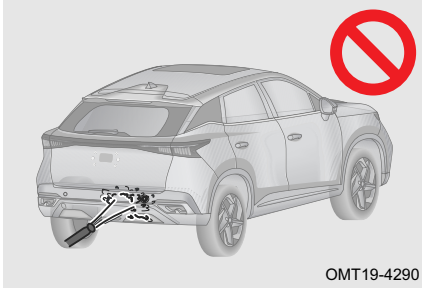

When washing vehicle, use a soft cloth or water (low water pressure) to wash off foreign matter such as snow, mud, and dust on the surface of the radar sensor.

High pressure water flow such as water guns or large external forces may cause damage to the radar sensors. Do not pinch or impact the radar sensors, as this may cause radar sensor to fail to operate normally.

If the buzzer does not sound when reversing, please check the followings:

- If there is foreign matter on the surface of radar sensor.
- Radar sensors cannot detect wires and fences. Check if radar sensor surface is frozen.
- If the vehicle has been parked for a long time in hot or cold weather.
- If cause cannot be found, please contact authorized service centre for inspection and repair as soon as possible.

5-14. Multi-Collision Brake System (MCB)

Multi-Collision Brake System (MCB)

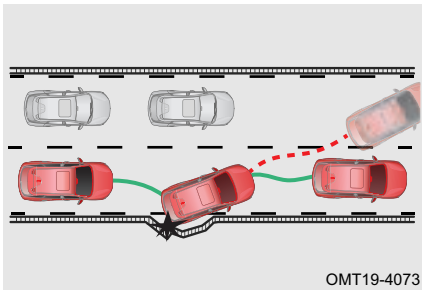

When the multi-collision brake system detects that the vehicle has collided, the electronic stability control system performs active braking, and decelerates the vehicle to prevent the vehicle from being collided again. In the process of braking, it can still maintain control of the vehicle, which can further ensure the safety of yourself and passers-by.

Function limit

Under the following conditions, multi-collision brake system may not operate correctly:

- When there is a malfunction in the airbag system.
- When there is a malfunction in the electronic stability program system.
- When the electronic stability program system is turned off.

5. DRIVING ASSIST

5-15. Braking Force Control System

Electronic Stability Program System (ESP)

Introduction

ESP keeps vehicle stability when oversteering or understeering. When oversteering or understeering is detected, system applies brake to one or more wheels to enhance control of vehicle stability. ESP also extends some functions (such as ABS and EBD, etc.) to ensure the lateral stability when vehicle driving.

Usage method

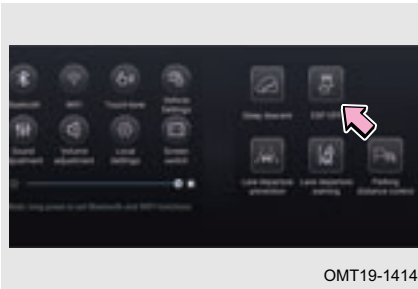

Press ESP OFF switch on the audio system to turn off ESP; Press ESP OFF switch again to turn on ESP.

READ

- When driving vehicle for the first time, ESP is on by default.
- ESP cannot be turned off during operation.

Electronic stability program system (ESP) indicator

When ESP is turned off, "  " yellow indicator in instrument cluster remains on.

When ESP is operating, "  " yellow indicator in instrument cluster blinks.

When ESP is malfunctioning, "  " yellow indicator in instrument cluster remains on.

READ

Replacing the non-full size spare tyre will cause the electronic stability program system (ESP) abnormal alarm, it will automatically return to normal when driving 0.6214 miles (1 km) after replacing the normal size tyre.

⚠ WARNING

- When ESP is malfunctioning, please go to authorized service centre for inspection and repair as soon as possible.
- Even when ESP is working, high speed driving, sharp turns or poor road conditions can cause accidents.
- ESP function does not completely ensure that you can take over vehicle if it has lost control due to various extreme situations. Even with ESP, always follow laws and regulations to avoid accidents.

Function limit

Under the following conditions, Electronic Stability Program System (ESP) needs to be turned off:

- When driving with tyre chains.
- When starting vehicle on power tester.
- When driving on roads with deep snow or loose gravel.

📖 READ

To improve vehicle traction when driving on sand or gravel, it is recommended to turn ESP off.

Anti-lock Brake System (ABS)**Introduction**

ABS can prevent wheel from being locked in excessive braking or braking on a slippery road, avoiding vehicle sideways slippage or vehicle drifting and keeping vehicle stability.

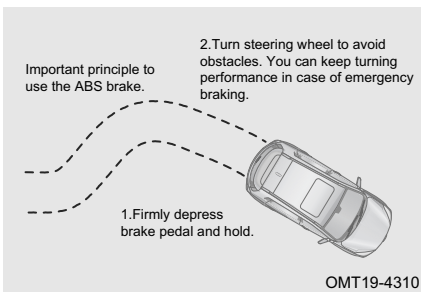

ABS does not function during normal braking and it will be turned on immediately only during sudden braking (brake pedal pulsates with noise, ensuring brake performance and steering performance, if the space is enough, the vehicle can also avoid obstacles). Never release brake pedal in this case.

⚠ CAUTION

- Always drive carefully and make sure to decelerate during turning.
- When ABS is malfunctioning, please go to authorized service centre for inspection and repair as soon as possible.
- Although ABS can ensure the best braking effect, braking distance will vary largely due to road conditions.

5. DRIVING ASSIST

WARNING

- Also, ABS cannot eliminate risks arising from close-following driving, driving through water, turning quickly or driving on poor road surfaces and cannot avoid accidents caused by inattentive or inappropriate driving.
- ABS cannot ensure that brake distance can be shortened in any situations. When vehicle is equipped with tyre chain, on sand or snow covered roads, vehicles with ABS may require a longer braking distance compared to vehicles without ABS.

Anti-lock brake system (ABS) indicator

When there is a fault in ABS, "  " yellow indicator in instrument cluster remains on.

WARNING

When ABS indicator and brake system indicator remain on at the same time, park your vehicle on a safety place far away from major traffic and go to authorized service centre for inspection and repair immediately.

Function limit

■ ABS will make operation sound in following conditions:

- Rebounding sound of brake pedal.
- Impacting sound between suspension and vehicle body due to emergency braking.
- Operation sound of motor, solenoid valve and return pump in hydraulic unit.
- Operation sound of solenoid valve when EBD is intervened in braking.
- Buzz will be heard for a short time after vehicle is powered on or starting engine, indicating system self-test is performed.

■ Always maintain a safe distance from vehicle ahead in the following situations:

- When driving on rough roads.
- When driving on roads with potholes or uneven surfaces.
- When driving with tyre chains.
- When driving on dirt, gravel or snow-covered roads.

CAUTION

Tyre size and tread pattern wear will seriously affect ABS performance. Replacement tyres should have same size, load capacity and structure as original one. When a tyre is faulty, it is recommended to replace with a original brand at authorized service centre.

⚠ WARNING

- When driving on rainy days, properly control the vehicle speed, because if the wheel spins or slips, ABS will not control the vehicle.
- Although ABS can help to control vehicle, make sure to drive carefully, maintain a moderate speed and keep safe distance from preceding vehicles. There are certain limitations in vehicle stability and steering wheel operation effect even ABS operates.

Extended Function**Electric brake force distribution system (EBD)**

EBD automatically adjusts braking force distribution ratio of front and rear axles according to axial load transfer difference caused by braking to improve braking efficiency. In addition, EBD works together with ABS to improve braking stability. Also, when braking round a corner, brake force of inside and outside wheels can be adjusted to improve braking stability.

Traction control system (TCS)

During starting off or rapidly acceleration, drive wheels may slip. In the case of a slippery road such as snowy or icy road, direction could get out of control and cause a dangerous situation. When TCS detects that driven wheel speed is lower than drive wheel speed (a kind of wheel slip symptom) using sensor, it sends a signal to adjust ignition timing, reduce throttle opening, downshift or brake wheels so that wheel no longer slips.

Brake assist system (BAS)

Generates an increased level of braking force after the brake pedal is depressed when the system detects a panic stop situation.

5-16. Data Privacy

Chery Automobile Co., Ltd. (hereinafter referred to as "we" or "us") is the manufacturer responsible for privacy by design (PbD) of your vehicle.

Driver Drowsiness and Attention Warning (DDAW)

Our vehicle's Driver Drowsiness Alert Warning (DDAW) system works to detect signs of driver fatigue. It does this by monitoring a range of parameters within a recent time window, including the proportion of time your eyes are open, blink rate, direction of gaze, length of gaze, yawning, as well as vehicular parameters such as speed, gear position, car door status, steering wheel angle, and direction of turn. The system uses this information to make a comprehensive judgement about driver fatigue and issue alerts as necessary.

5. DRIVING ASSIST

CAUTION

Please be aware that the data collected by the DDAW system is required by regulations, collected for immediate processing, and is not stored. According to the regulations, DDAW will be enabled by default. The collected data is used for algorithmic recognition and discarded immediately after use. All data is processed within the vehicle and does not leave the vehicle.

Advanced Driver Assistance System (ADAS)

In order to implement the drive assistance function, the car side will use the vehicle's front, flanks, and rear cameras to collect image data on the road during driving or after parking, image data surrounding the vehicle to complete drive assistance function. The camera recordings use the vehicle's external cameras to learn how to recognize things like lane lines, street signs and parking signs and traffic light.

CAUTION

Please be aware that the processing data within our system is designed for immediate use and analysis. We do not store any of the data that is processed. This data is necessary for legitimate interests and also to fulfil legal and other official requirements.

Emergency call (eCall)

In the event when you are in a traffic accident or you press the SOS button for roadside assistance, the eCall system on the in-vehicle terminal will provide your vehicle location, contact information and additional required information to the Public Safety Answering Point (PSAP) which is set up by government authority. The collection and sharing of these data comply with the requirements of laws and regulations, which only includes GPS, speed, directions of your vehicle, the time when you trigger the eCall, the eCall status, Vehicle Identification Number (VIN), vehicle model, power type and Recorded voice data.

CAUTION

We collect this data to fulfil our legal obligations outlined in vehicle security regulations.

6-1. Basic Knowledge of Vehicle Emergency	If Battery is Flat..... 198
Hazard Light..... 190	If Your Vehicle Cannot Start Normally..... 200
Reflective Strip 191	6-3. Towing
Warning Triangle..... 191	Towing Vehicle..... 200
Spare Tools (If equipped) 191	Installing Towing Eyelet..... 202
6-2. Vehicle Emergency Handling	Emergency Towing..... 202
If You Have a Flat Tyre While Driving 192	6-4. Fuse
If Engine Coolant Temperature is High 197	Fuse Box 203
	Checking Fuse..... 204
	Replacing Fuse..... 205

6. IN CASE OF AN EMERGENCY

6-1. Basic Knowledge of Vehicle Emergency

Hazard Light

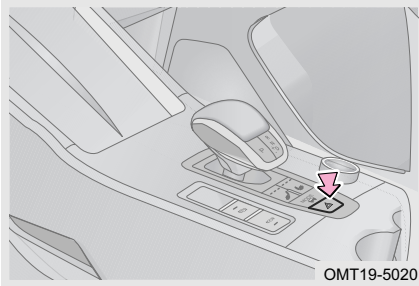

In case of vehicle failure or traffic accident etc., please turn on the hazard lights to warn other vehicles, so as to avoid the secondary accident.

Press hazard light switch, Directional indicator lights flash and the directional signal light indicator on instrument cluster flashes at the same time; Press the switch again, directional indicator lights and directional signal light indicator will go out.

READ

- The hazard lights can still work when the vehicle power is turned to OFF mode.
- The hazard lights are automatically activated when the airbag is operating.

CAUTION

To prevent battery from being depleted, do not turn on the hazard lights more than necessary when the engine is not started.

Emergency braking alarm function

When brake pedal is depressed in emergency at higher speed, the lights and directional signal light indicator on instrument cluster flash quickly; Release the brake pedal, press the hazard light switch or turn the vehicle power to OFF mode, the directional indicator lights and directional signal light indicator on instrument cluster will stop flashing.

Reflective Strip

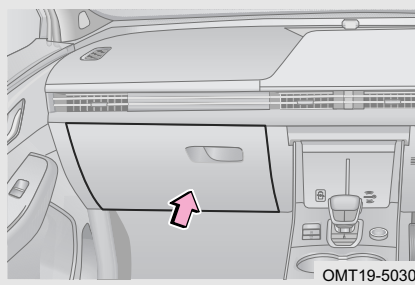

The reflective strip is placed in the glove box.

In case of vehicle failure or traffic accident etc., wear the reflective strip with reflective strip facing outwards. It can warn other vehicles to avoid secondary accidents.

Warning Triangle

Warning triangle is located under the luggage compartment carpet.

In case of vehicle failure or traffic accident etc., the reflective property of warning triangle can warn other vehicles to avoid secondary accidents.

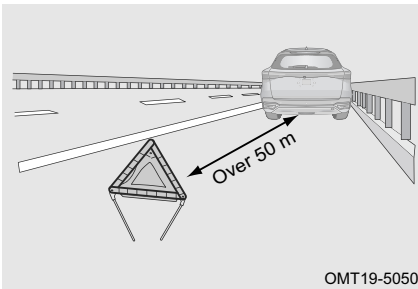

Place the warning triangle at a distance of more than 50 m behind the vehicle on a normal road.

Place the warning triangle at a distance of more than 150 m behind the vehicle on the motorway.

Place the warning triangle at a distance of over 150 m behind the vehicle in rain or when steering.

Spare Tools (If equipped)

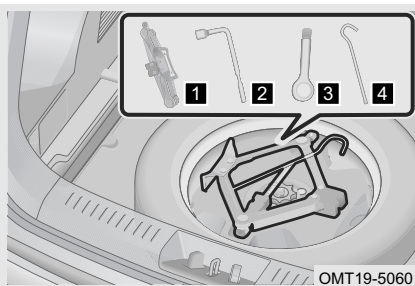

- 1** Jack
- 2** Wheel bolt wrench
- 3** Towing eyelet
- 4** Jack rocker

6. IN CASE OF AN EMERGENCY

6-2. Vehicle Emergency Handling

If You Have a Flat Tyre While Driving

If a tyre goes flat while driving, slow down gradually, grip the steering wheel with two hands and keep driving straightly. Stop vehicle to a safe place away from the traffic road.

1. Preparations before replacing flat tyre.

Step 1: Stop vehicle on solid, level ground;

Step 2: Apply parking brake and shift the shift lever to P;

Step 3: Turn vehicle power to OFF mode, and turn on hazard lights;

Step 4: Have everyone get out of vehicle, pull over and stay away from traffic;

Step 5: Wear reflective strip, and place the warning triangle 50 m - 150 m behind the vehicle (according to actual condition).

CAUTION

Do not continue driving with a flat tyre. Driving even a short distance can damage the tyre beyond repair.

2. Take out the spare tyre.

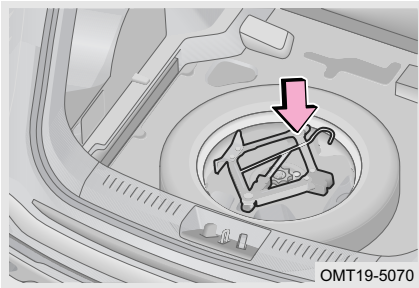

Step 1: Open boot door, lift the luggage compartment carpet and take out spare tools;

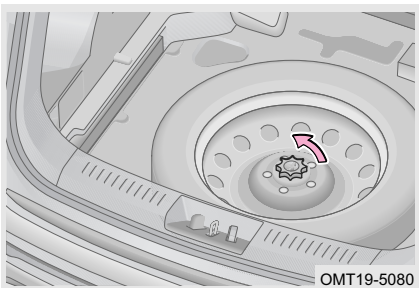

Step 2: Rotate fixing device of spare tyre counterclockwise to remove it, and then take out spare tyre.

3. Remove the flat tyre.

6. IN CASE OF AN EMERGENCY

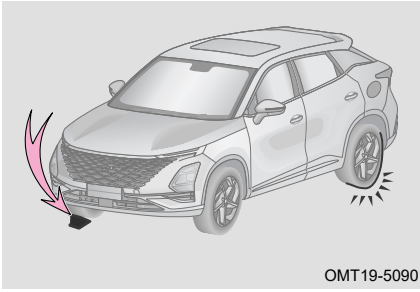

OMT19-5090

Step 1: Put a block under the tyre diagonally opposite to flat tyre to prevent vehicle from rolling.

Flat Tyre	Wheel Block Position
Front left wheel	Behind rear right wheel
Front right wheel	Behind rear left wheel
Rear left wheel	Behind front right wheel
Rear right wheel	Behind front left wheel

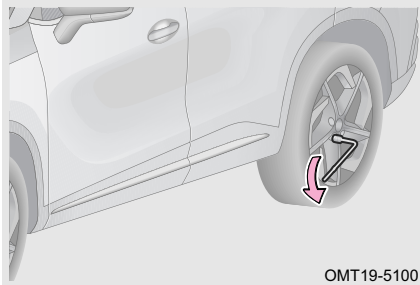

OMT19-5100

Step 2: Fit wheel bolt wrench to wheel bolt of flat tyre, set the handle on left side, hold the end of wrench handle and push it downward, loosen each bolt of flat tyre about one-half turn;

CAUTION

When removing wheel bolts with the wrench, be careful not to drop them as they can be damaged easily.

WARNING

Do not loosen the bolts completely. Otherwise, wheel may be ejected out because of the vehicle pressure, causing personal injury.

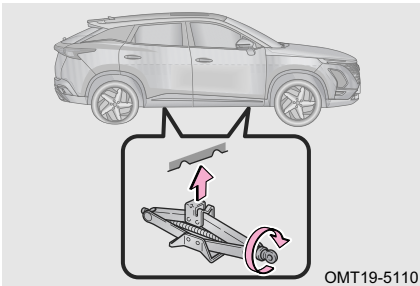

OMT19-5110

Step 3: Place jack on firm and level ground, turn jack handle clockwise by hand, making the notch of jack contact with the correct jacking-up point.

READ

Jack the vehicle to a proper height at which tyre can be replaced.

WARNING

Never put any part of body under the vehicle when vehicle is jacked up to avoid personal injury.

6. IN CASE OF AN EMERGENCY

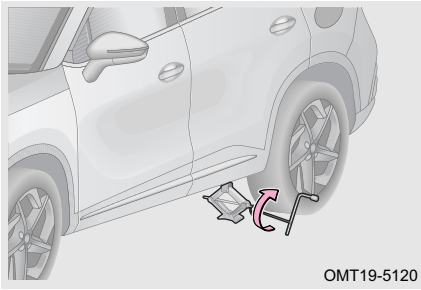

Step 4: When the notch of jack contacts correct jacking-up point, fit jack rocker into jack, and then fit wheel bolt wrench into jack rocker, and turn the wheel bolt wrench clockwise to jack up the vehicle;

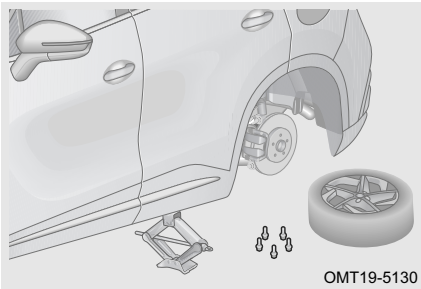

Step 5: Remove the wheel bolts of flat tyre counterclockwise with the wheel bolt wrench, and remove the flat tyre.

CAUTION

Place the flat tyre on ground with rim facing upward, so as to avoid scratching the rim surface.

4. Install the spare tyre.

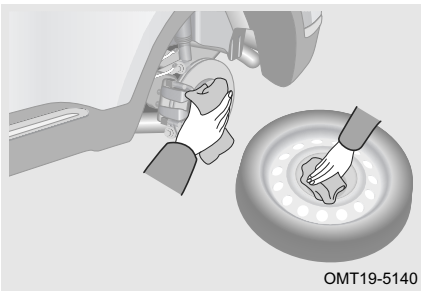

Step 1: Remove any attachments from mounting surface. Make sure wheel hub well contacts with wheel surface, and install spare tyre;

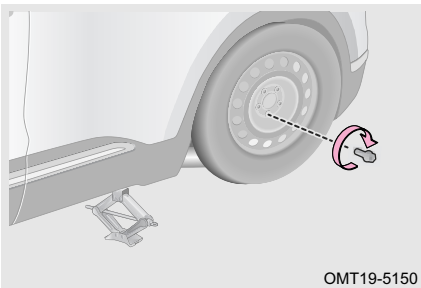

Step 2: When installing wheel bolts, screw into all wheel bolts clockwise by hand. Then straighten the spare tyre, and pretighten all wheel bolts with wheel bolt wrench;

CAUTION

Do not apply oil or grease on wheel bolts.

6. IN CASE OF AN EMERGENCY

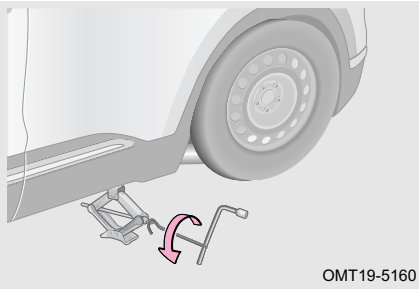

Step 3: Make sure all people around the vehicle stay in the safe area, fit jack rocker into jack, and wheel bolt wrench into jack rocker, and turn wheel bolt wrench counterclockwise to lower the vehicle;

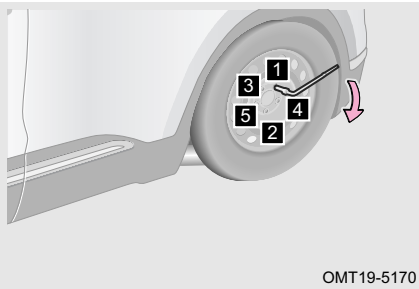

Step 4: Using wheel bolt wrench, tighten bolts in sequence shown in illustration. Repeat the process 2 to 3 times to ensure that wheel bolts are tightened in place;

Step 5: Stow the flat tyre and place jack, warning triangle and spare tools in original place;

Step 6: If the pressure of spare tyre is insufficient, drive vehicle slowly to the nearest authorized service centre to inflate the tyre to correct pressure.

6. IN CASE OF AN EMERGENCY

WARNING

- Drive at specified speed of 49 mph (80 km/h) or less with a non-full size spare tyre, it is not designed for driving at high speeds. Failure to observe this precaution may lead to an accident causing death or injury.
- Tighten wheel bolts to 130 ± 10 N·m after replacing the non-full size spare wheel. Drive slowly to the nearest authorized service centre (advised distance: ≤ 49 miles (80 km) to replace with a standard tyre. Otherwise, the wheels may fall off due to loose bolts.
- The vehicle becomes lower when driving with non-full-size spare tyre compared to when driving with standard tyres. Be careful when driving over uneven road surfaces.
- Spare tyre is designed only for emergency use and should be used only for very short periods. It should never be used for long drives or extended periods.
- Remember that the non-full-size spare tyre provided is specifically designed for use with your vehicle. Do not use your spare tyre on another vehicle.
- Do not use more than one spare tyres simultaneously.
- Replace the spare tyre with a standard tyre as soon as possible.
- Avoid sudden acceleration, abrupt steering, sudden braking and shifting operations that cause sudden engine braking.

If Engine Coolant Temperature is High

If the engine coolant temperature is high during driving, and engine coolant temperature gauge approaching H area or red indicator "🔥" on instrument cluster comes on, please stop vehicle to a safe place away from the traffic road.



Step 1: Stop vehicle on solid, level ground;

Step 2: Apply parking brake and shift the shift lever to P;

Step 3: Turn off A/C system (Water dripping from air conditioning after use is normal);

Step 4: Turn vehicle power to OFF mode after idling for several minutes, and turn on hazard lights;

Step 5: Before opening the bonnet, check whether there is steam or coolant overflow or leakage. Only open the bonnet when there is no steam or coolant overflow or leakage, otherwise, burns may occur;

Step 6: Check the coolant level. If it is normal, it may be caused by the failure of radiator fan. Please contact authorized service centre for inspection and repair immediately;

Step 7: Check the coolant level. If it is low, please contact authorized service centre for inspection and repair immediately.

READ

If the coolant level is low, water can be used temporarily, please go to authorized service centre to replace coolant as soon as possible.

CAUTION

If engine overheats, please contact the authorized service centre for inspection and repair immediately.

6. IN CASE OF AN EMERGENCY

If Battery is Flat

Jump-starting

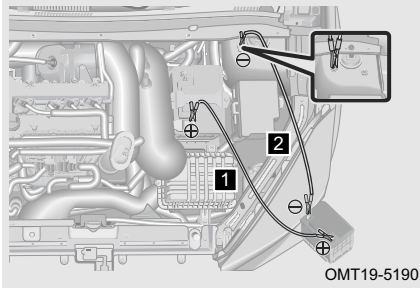

Step 1: Turn vehicle power to OFF mode, and connect jumper cables;

- 1** Connect one end of positive cable to positive terminal (+) of battery of discharged vehicle, and the other end to the positive terminal (+) of battery on rescue vehicle.
- 2** Connect one end of negative cable to negative terminal (-) of battery on rescue vehicle, and the other end to unpainted metal part of discharged vehicle.

Step 2: Start the engine of rescue vehicle, slightly increase engine speed and maintain for approximately 5 minutes to temporarily charge the battery of discharged vehicle;

Step 3: If the discharged vehicle is still unable to start, check whether the jumper cable is connected normally, and then charge the battery;

Step 4: Once the engine is started on discharged vehicle, remove jumper cables in the reverse order of connection (negative cable first and then the positive cable).

CAUTION

- Do not jump start unless you are sure that the battery voltage for jumper starting is 12 to 13 V.
- If the battery lacks power, please go to authorized service centre for inspection and repair as soon as possible.
- The negative terminal of battery on rescue vehicle should not be directly connected to negative terminal of battery on discharged vehicle.
- When connecting and removing jumper cables, ensure that they do not become entangled in fan, belt, etc.
- Ensure that the jumper cables are properly connected and keep a certain distance between terminals, to prevent the jumper cables from touching each other or touching other metal parts of the vehicle.
- Before turning off vehicle power or locking the vehicle, make sure that the electrical appliances of vehicle are turned off, to prevent the vehicle from being unable to start normally due to battery power loss.

⚠ WARNING

- The surge protection jumper cables should be used.
- Do not smoke, use matches, cigarette lighters or allow open flame near the battery.
- If you are unsure about how to follow the procedure, we strongly recommends that you seek help from professional serviceman or at a authorized service centre.

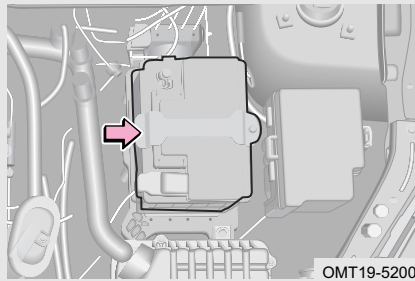
Replacing battery

Step 1: Vehicle power is turned to OFF mode;

Step 2: Open the bonnet;

Step 3: Remove the negative (-) battery terminal cable;

Step 4: Remove the positive (+) battery terminal cable;

Step 5: Remove the battery holder and the battery;

Step 6: Install a new battery that has the same specification as the used one;

Step 7: Install the new battery properly in the reverse order of removing.

🌿 ENVIRONMENTAL PROTECTION

Battery contains acid which is poisonous and corrosive. Please deal with it according to the local regulations and provisions regarding environmental protection.

⚠ CAUTION

While removing battery, be careful to avoid the metal tool contacting with both battery terminals or touching the positive (+) battery terminals and body at the same time.

⚠ WARNING

- Do not leave battery within the reach of children.
- Do not smoke, use matches, cigarette lighters or allow open flame near the battery.
- Always wear gloves and safety glasses during operation, as battery contains acid which is poisonous and corrosive. Do not lean on the battery.
- If acid spills on your skin or clothes, the liquid must be neutralized with alkaline water (such as: soap) immediately, and then wash it with clean water. Get emergency medical attention immediately if necessary.

6. IN CASE OF AN EMERGENCY

If Your Vehicle Cannot Start Normally

If your vehicle cannot start normally, first make sure you have followed the correct starting procedures and check if fuel is sufficient.

■ Starter speed is too low, but vehicle cannot start normally

Step 1: Check if battery terminals are tight and clean;

Step 2: Turn on headlights. If the light is dim, it indicates that the battery is discharged. Please try jump starting.

Step 3: Try to start engine again, if it still cannot start normally, the starting system may be malfunctioning. Please contact authorized service centre for inspection and repair immediately.

■ Starter speed is normal, but vehicle cannot start normally

Step 1: Turn vehicle power to OFF or ACC mode, try to start the engine again;

Step 2: If the engine still cannot be started normally, it may cause excessive fuel in cylinder due to repeat starting. Turn vehicle power to OFF mode, try to start engine again after a few minutes;

Step 3: Try to start engine again, if it still cannot start normally, please contact authorized service centre for inspection and repair immediately.

 CAUTION

- To avoid damage to the starter, starting operation should not exceed 15 seconds each time.
- If vehicle becomes difficult to start or stalls frequently, please go to authorized service centre for inspection and repair as soon as possible.

6-3. Towing

Towing Vehicle

Towing must comply with local laws about towing.

Before towing the vehicle, release parking brake (for emergency releasing electric parking, refer to "Brake System"), and shift the shift lever to N.

Correct towing methods

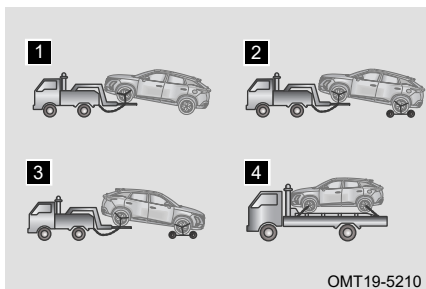

1 For front-wheel drive vehicles:
Tow with a wheel lift-type truck from front, and secure the vehicle firmly.

2 For front-wheel drive, rear-wheel drive and 4WD vehicles: When towing with a wheel lift-type truck from front, use a towing dolly under the rear wheels, and secure the vehicle firmly.

3 For front-wheel drive, rear-wheel drive and 4WD vehicles: When towing with a wheel lift-type truck from behind, use a towing dolly under the front wheels, and secure the vehicle firmly.

4 For front-wheel drive, rear-wheel drive and 4WD vehicles: When towing with a flatbed truck, secure the vehicle firmly.

⚠ CAUTION

- It is recommended to use flatbed truck for 4WD vehicles.
- Use a flatbed truck if the vehicle's wheels or axle are damaged.
- Ensure that there is a proper clearance between the wheels not lifted and ground. Otherwise, the bumper and chassis of towed vehicle will be damaged during towing.

Wrong towing methods

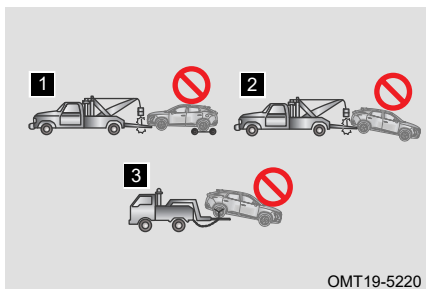

1 Tow with sling-type truck sling from front of the vehicle.

2 Tow with sling-type truck sling from rear of the vehicle whilst front wheels are on the ground.

3 Tow with wheel lift-type truck sling from rear of the vehicle whilst front wheels are on the ground.

⚠ CAUTION

Do not tow with a sling-type truck to prevent body damage.

6. IN CASE OF AN EMERGENCY

Installing Towing Eyelet

Front towing eyelet

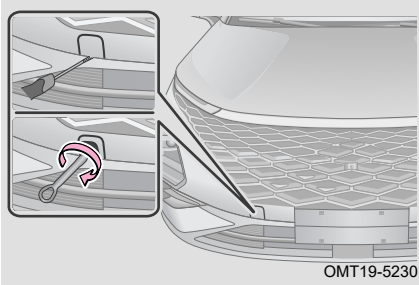

Step 1: Use a screwdriver with its tip taped to remove the front towing eyelet hole cover;

Step 2: Install towing eyelet into eyelet hole in a clockwise direction. Then tighten it firmly with wheel bolt wrench.

Rear towing eyelet

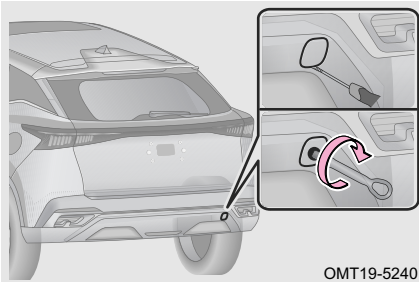

Step 1: Use a screwdriver with its tip taped to remove the rear towing eyelet hole cover.

Step 2: Install towing eyelet into eyelet hole in a clockwise direction. Then tighten it firmly with wheel bolt wrench.

CAUTION

- Only use specified towing eyelet. Otherwise, vehicle may be damaged.
- Towing rope or towing bar can be installed only when towing eyelet is installed in place.
- Drive the vehicle slowly and smoothly when towing. Impact due to excessive tension may damage the vehicle.

WARNING

Make sure that towing eyelet is installed securely. Otherwise, the towing eyelet may come loose when towing, which may cause an accident, resulting in death or serious injury.

Emergency Towing

If flatbed truck is not available during towing, your vehicle may be temporarily towed using a towing hook. This should only be attempted on hard surfaced road for short distances at low speed.

When using towing hook, driver must seat in towed vehicle to operate steering wheel and brake pedal, and vehicle wheels, drive train, axle, steering system and braking system must be in good condition.

Before emergency towing, release parking brake (for details of emergency releasing electric parking, refer to "Brake System"), shift the shift lever to N, and turn vehicle power to ACC or ON mode.

CAUTION

- Do not perform emergency towing for long periods of time.
- Secure a towing cable, chain or lever to the vehicle towing eyelet.
- Never tow a vehicle heavier than this vehicle, otherwise the vehicle may be damaged.
- Both drivers must be familiar with the towing process, otherwise they cannot carry out towing work.
- Tow vehicle as straightly ahead as possible, do not tow vehicle from side to avoid damaging vehicle.
- If engine is not started, assist system will not work, therefore, braking and steering will be more difficult than usual. So, please operate carefully.
- We strongly recommends that you seek help from professional serviceman or authorized service centre.
- If towed vehicle still cannot move, do not forcibly continue towing to avoid secondary damage to vehicle. We strongly recommends that you seek help from professional serviceman or authorized service centre.

WARNING

- To avoid personal injury, people other than driver should stay away from the vehicle when it is towed.
- When towing vehicle, avoid sudden start-off or erratic driving maneuvers which would apply excessive force on the towing eyelet, cable, chain or lever. The towing eyelet, cable, chain or lever may break and cause vehicle damage or serious personal injury.

6-4. Fuse

Fuse Box

Fuses are used to protect electrical components and circuits to avoid short circuit or overload. If fuse is blown, the protected components and systems will not work properly.

6. IN CASE OF AN EMERGENCY

Front compartment fuse box

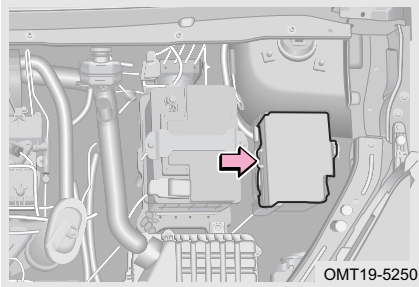

Step 1: Vehicle power is turned to OFF mode.

Step 2: Disconnect the negative battery terminal cable.

Step 3: Remove front compartment fuse box cover to inspect or replace fuse.

Instrument panel fuse box

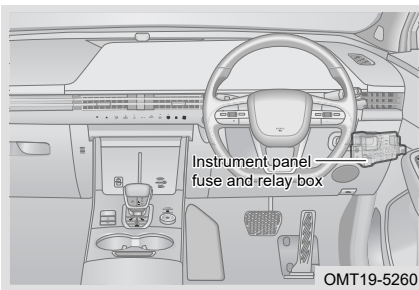

Step 1: Vehicle power is turned to OFF mode.

Step 2: Disconnect the negative battery terminal cable.

Step 3: Remove instrument panel lower right protector to inspect or replace fuse.

READ

- Check suspected fuses according to the fuse and relay box layout.
- To prevent damage to the vehicle, be careful when removing/installing the instrument panel lower right protector. Please contact authorized service centre as necessary.
- The fuse box must be clean, keep it away from dampness when opening, as dirt and moisture may damage the electrical system.

Checking Fuse

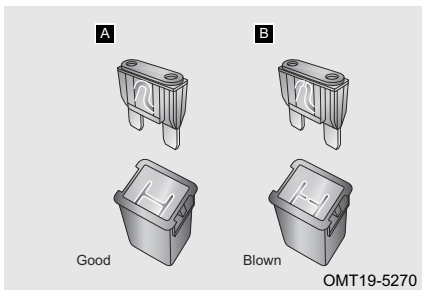

A Good fuse.

B Blown fuse.

READ

If the fuses are blown, they must be replaced.

Replacing Fuse

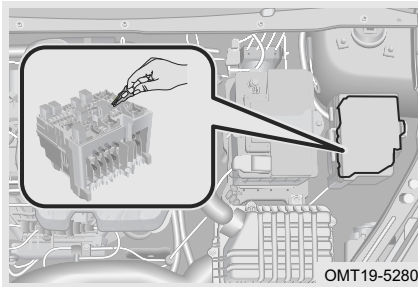

Step 1: Vehicle power is turned to OFF mode.

Step 2: Check fuses according to the fuse and relay box layout.

Step 3: Pull the suspected fuse out by a fuse remover.

Step 4: Check if the fuse is blown. If you are not sure whether the fuse has blown, replace the suspected fuse with spare fuse that has the same amperage rating. You can see the amperage rating on the schematic diagram inside the fuse box cover.

READ

If a spare fuse is unavailable, you can use a fuse with same specification. It is better to purchase a set of spare fuses and put them in vehicle for emergency use.

CAUTION

- Do not modify any fuses or fuse boxes.
- Only install a fuse that has the same amperage rating as used one. Never replace a fuse with a wire, even as a temporary replacement. Otherwise, this may cause serious damage to electrical appliances, or even fire.

7-1. Repair and Maintenance

Repair and Maintenance ...	208
Authorized Service Centre is at Your Service ...	208
Safety Check	209

7-2. Normal Maintenance

Normal Maintenance	210
Checking Oil Level	211
Checking Transmission Fluid Level	212
Checking Brake Fluid Level	212

Checking Coolant Level	213
Checking Radiator and Condenser	214
Checking Drive Belt	214
Checking Tyres	215
Tyre Rotation	217
Checking Battery	217
Checking Air Conditioning Filter	217
Checking Windshield Washer Fluid	218
Checking Wiper Blades	218

7. MAINTENANCE

7-1. Repair and Maintenance

Repair and Maintenance

There are two types of repair and maintenance: one is normal maintenance, which can be done by the customers; the other is scheduled maintenance, inspection and repair, which needs to be completed by authorized service centre.

For the details of regular maintenance, inspection and repair methods, please refer to "Regular Maintenance" in this section; Regular maintenance can be helpful for you to find and eliminate potential dangers in time to prevent malfunctions. Scheduled maintenance of your vehicle is essential. Please strictly follow the maintenance schedule to perform maintenance, ensuring that your vehicle maintains the best performance and good operating conditions, thus effectively extending the service life of the vehicle.

Please use the recommended fluid, or your vehicle may be damaged.

Authorized Service Centre is at Your Service

Authorized service centre

It is recommended to use OEM parts and materials. Please take your vehicle to authorized service centre to ensure that your vehicle is maintained to the highest standard.

Authorized service centre offers a professional service. For vehicle service, please remember that your authorized service centre knows your vehicle best, and has the professional technicians and OEM parts to complete the job to the highest standard.

ENVIRONMENTAL PROTECTION

Used engine oil, brake fluid, coolant, steering fluid (if equipped), batteries and tyres should only be disposed of by qualified waste disposal agencies or after consultation with manufacturers, and should not be taken out with household waste or disposed of into the communal drainage system.

Service arrangements

When going to authorized service centre for vehicle service, make sure to carry all required documents. Not all the work to be performed is covered by the warranty. For detailed expenses, consult your service advisor. Keep a service record on your vehicle. Usually, this record can provide valuable reference information.

Prepare a list sheet covering vehicle malfunctions and specific service items. If you have had an accident or any item serviced is not included in the service records, let your service advisor know.

If you list many service items and you must get your vehicle on the day, communicate with your advisor to rank the items by priority.

Safety Check

It is better to perform a safety check before driving vehicle, which will improve your driving safety and enjoyment.

WARNING

While inspecting vehicle, do not start the vehicle.

Daily check

Check whether paint surface is scratched, light shade is damaged, body is tilted, wheel bolts are missed or loosened, water/oil leakage occurs, door/bonnet/boot door/glass is damaged.

Check that engine oil level, brake fluid level, coolant level, steering fluid level (if equipped) and windshield washer fluid level is normal.

Check cold tyre pressure and conditions (such as: wear, swelling, aging cracks, mechanical damages, etc). Also check the spare tyre.

Check whether seat belt buckles fasten securely. Make sure belts are not worn or frayed.

Check whether lighting of lights is normal.

Check whether meter indicators are normal.

Monthly check

Clean vehicle surface, inside of engine bonnet (dust on surface of radiator and condenser, and remaining oil of engine body), vehicle interior and luggage compartment.

Check assembly, pipes, hoses and tanks for leaks; Check whether battery and cable are corroded and loosened; Check whether circuits are damaged, loosened or disconnected; Check that no water/oil leakage has occurred.

Check whether air condition is operating properly.

Check whether parking brake is operating properly.

Check whether spare fuses and spare tools (such as: jack, wheel bolt wrench, etc.) are equipped.

READ

Used engine oil, brake fluid, coolant, batteries and tyres can be disposed only by qualified waste disposal agencies, or consult supporting manufacturers for disposal of them. It is not permitted to dispose of them with household waste or discharge them into public drainage system.

7. MAINTENANCE

7-2. Normal Maintenance

Normal Maintenance

Be sure to follow the correct maintenance procedures provided in this section if you perform do-it-yourself maintenance.

This section only lists the simple maintenance instructions which can be performed by customers. However, there are still many items that have to be maintained by qualified technicians with special tools.

CAUTION

- Check for any tools or cloths that may have been left behind before closing the bonnet.
- Do not drive vehicle with the air filter removed, otherwise, excessive engine wear could occur.
- Correctly add fluid to the appropriate level. If some fluid splashes onto the vehicle, be sure to immediately wash it off with a wet cloth, to avoid damage to the painted surface.

WARNING

- If the engine is very hot, do not open the coolant reservoir cap to prevent scalding injury.
- When the engine is running, keep hands, clothing and tools away from engine drive belts and cooling fan.
- Do not smoke near fuel filler or battery, otherwise, it may cause sparks or open flames, resulting in a fire.
- There is a high voltage in the electronic ignition system. Do not touch these components while the engine is running or the vehicle power is turned on.
- Right after driving, engine, radiator, exhaust manifold and cylinder head will be very hot, so never touch them. Prevent any loose clothing from getting caught in the fan and causing personal injury because the cooling fan may automatically start and run at any time.

Checking Oil Level

Checking engine oil (for 1.6T engine)

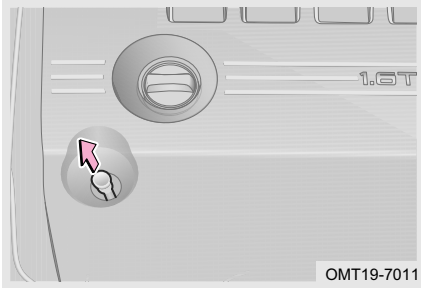

OMT19-7011

With the engine stalling and cooled down, check the oil level with the dipstick.

Step 1: Warm up the engine and then stop the vehicle on a level ground. Wait for approximately 5 minutes after turning off engine;

Step 2: Open the engine bonnet, pull the dipstick out and wipe it with a clean cloth;

Step 3: Insert the dipstick to the bottom uniformly and slowly;

Step 4: Leave the vehicle as is for approximately 3 seconds, pull the dipstick out again and check if oil level is correct.

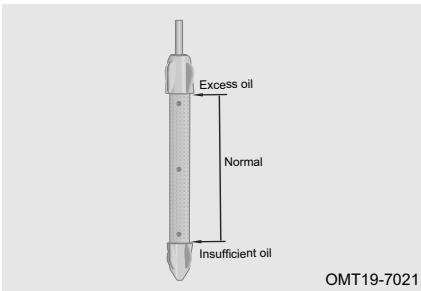

OMT19-7021

Put a cloth under the dipstick to avoid oil spilling onto engine or vehicle body.

Do not check the oil level immediately after the engine warms up, and wait until the oil returns into the bottom of engine.

Adding engine oil (for 1.6T engine)

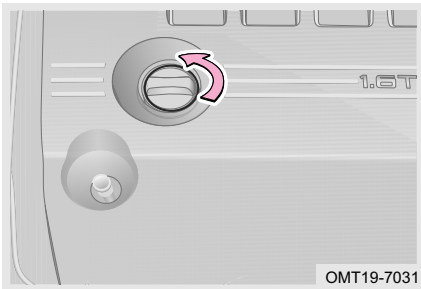

OMT19-7031

Step 1: Turn the engine oil filler cap counterclockwise to open it;

Step 2: Use the funnel to add a small amount of engine oil several times and check the oil level with a dipstick again;

Step 3: When the level reaches within the correct range, turn the engine oil filler cap clockwise to tighten it.

7. MAINTENANCE

ENVIRONMENTAL PROTECTION

Do not discard the waste engine oil and filter in household waste, down the drain or spill on to the ground. Otherwise, it will cause serious environmental pollution. Please handle it according to the local regulations regarding to environmental protection.

CAUTION

- Do not overfill oil, or it may cause damage to engine.
- Only recommended engine oil can be used. Otherwise, all the direct or indirect loss incurred are at customer's own risk.
- If oil is accidentally spilled on the surface of the engine during filling of oil, clean the spilled oil with canvas and other tools before tightening the engine oil filler cap.
- The engine oil filler cap cannot be inverted after removal, to prevent misjudgment caused by oil back flow or the oil flowing through seal ring will overflow automatically after reassembly, resulting in an illusion of oil leakage from the engine oil filler cap.

Checking Transmission Fluid Level

Checking, adding and replacing of transmission fluid should be done by professionals. Please contact the authorized service centre.

Checking Brake Fluid Level

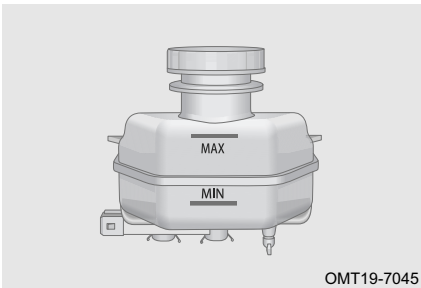

Brake fluid level should be between the "MIN" and "MAX" marks. If the level is at or below the "MIN" mark, add brake fluid and contact the authorized service centre for inspection and repair immediately.

CAUTION

- As the brake fluid is highly absorbent, do not leave the brake fluid reservoir cap open for a long period of time.
- Only recommended brake fluid can be used. Otherwise, all the direct or indirect loss incurred are at customer's own risk.
- If some brake fluid splashes onto the painted surface of vehicle body, be sure to clean it with a wet sponge or wash it off with water to avoid corroding the parts or painted surface.

⚠ WARNING

Never allow brake fluid to contact your skin or eyes. If the brake fluid splashes into your eyes, or on your skin, flush the area immediately with a great quantity of water. Get emergency medical attention immediately if necessary.

Checking Coolant Level**Checking coolant**

When engine is cold, the coolant level should be between the "MIN" and "MAX" marks. If the level is at or below the "MIN" mark, add coolant and contact the authorized service centre for inspection and repair immediately.

Adding coolant

Step 1: When the engine is cold, open the coolant reservoir cap, and add coolant until reaching "MAX" mark;

Step 2: Start and run the engine to a normal temperature. Observe the coolant level in the reservoir all the time, if the level falls below "MIN" mark, add coolant to an appropriate level in time until the coolant level does not fall down again;

Step 3: Turn off engine and check if coolant level is correct after engine cools down. If not, repeat above operations until level is normal;

Step 4: Install the coolant reservoir cap in place.

⚠ CAUTION

- If coolant level falls rapidly, check radiator, water pipe and water pump for leakage.
- Only recommended coolant can be used. Otherwise, all the direct or indirect loss incurred are at customer's own risk.
- Do not use inferior quality coolant, because the engine becomes excessively hot as running and inferior coolant cannot provide sufficient cooling and corrosion protection.
- In cold areas, it is necessary to replace with 100% stock solution of antifreeze.

7. MAINTENANCE

WARNING

- When engine is warmed up or becomes hot, the cooling system will be under high pressure. In this case, never open the coolant reservoir cap, otherwise, the escaping steam may cause scalding injury.
- The coolant is poisonous, so pay extreme caution not to spray the liquid on any part of the vehicle, human body or ground when adding coolant. If the coolant accidentally gets onto your skin or into eyes, please wash the affected area with a great quantity of water. Get emergency medical attention immediately if necessary.

Checking Radiator and Condenser

After the vehicle runs for a period of time, the front surface of condenser and radiator could be blocked with some insects, leaves and other objects, which could affect the performance of air conditioning and cooling system, resulting in air conditioning operating improperly and cooling system overheating. It is necessary to clean radiator and condenser at the time.

Condenser: Clean the condenser by blowing compressed air from rear to front through the radiator when the engine is turned off and cools down.

Radiator: It is recommended to clean the radiator surface every year. With engine turned off and cooled down, use compressed air or water to clean the radiator fins and blow off the insects and leaves, etc. Air and water pressure should not exceed 150 kPa. Otherwise, the radiator fins could be damaged.

CAUTION

- The material of radiator fins has good thermal conductivity, which is used to cool the coolant; Do not brush the fins, or it may cause damage to the fins, affecting the cooling effect.
- Do not spray water on the hot radiator while the engine is hot, otherwise, the generated high temperature steam may result in personal injury. Clean radiator when the engine is turned off and cools down.

Checking Drive Belt

Drive belt will be stretched after using for a period of time, and the belt tension is not enough, which may damage the vehicle, so it is necessary to regularly check the belt tension.

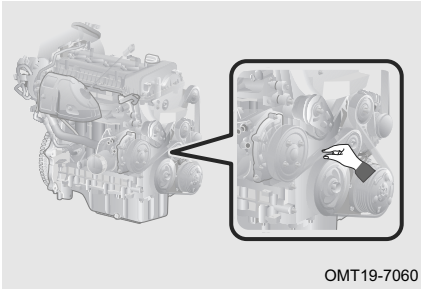

Step 1: Vehicle power is turned to OFF mode;

Step 2: Twist the belt with your fingers to check the rotation angle of belt;

Step 3: If rotation angle exceeds 90°, please go to authorized service centre for inspection and repair.

WARNING

When checking the drive belt tension, turn off the engine and cool it down to ensure that the engine belt is static.

Checking Tyres

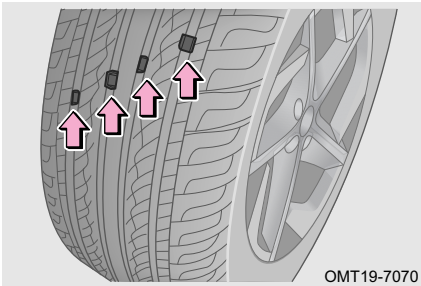

Check the tyre tread by tread wear mark. When tread wear reaches its limit, tread will be in the same plane as the wear band. If such condition occurs, the tyre performance and safety will be seriously impacted, and replacement is necessary.

ENVIRONMENTAL PROTECTION

Always discard a used tyre carefully. It should be handled according to the local regulations regarding to environmental protection.

■ Observe the following precautions. Failure to do so may lead to an accident, resulting in death or serious injury:

1. Do not use tyres that were used on another vehicle.
2. Do not mix tyres with remarkably different tread wear.
3. Do not use tyres if you do not know how they were used previously.
4. Do not mix tyres from different manufacturers, of different models or tread patterns.
5. Do not mix differently constructed tyres (such as radial, bias-belted or bias-ply tyres).
6. Speedometer can be affected by the tyre size. If the tyre size (diameter) is different from the genuine one, it will not display accurate speed, and may result in accidents, such accidents loss are not covered by the warranty.

7. MAINTENANCE

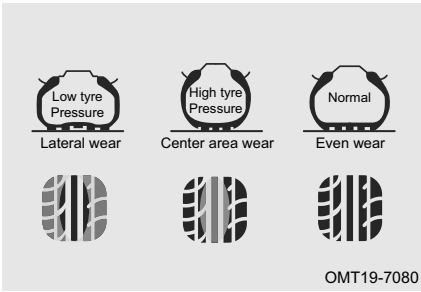

Incorrect tyre inflation pressure will lead to excessive fuel consumption, shorten the tyre service life and reduce the vehicle stability. Therefore, you should drive the vehicle with proper tyre pressure (For provisions about the tyre inflation pressure, please refer to the tyre pressure label on driver side B pillar). When cold tyre inflation pressure is higher than specified value or economic tyre pressure is used, driving comfort will be reduced accordingly. Please adjust it according to your needs.

■ Be sure to keep proper tyre inflation pressure. Otherwise, the following conditions may occur and result in death or serious injury:

1. Excessive wear.
2. Poor handling.
3. Uneven wear.
4. Poor sealing of the tyre bead.
5. Wheel deformation or tyre separation.
6. Possibility of blowouts resulting from overheated tyres.
7. A greater possibility of tyre damage caused by poor road conditions.

CAUTION

- It is normal that the tyre inflation pressure increases after driving for a period of time.
- If the tyre needs to be inflated frequently, please go to authorized service centre for inspection and repair as soon as possible.
- If a tyre often leaks or cannot be properly repaired due to a cut or other damages, it should be replaced.
- Use a tyre pressure gauge to check cold tyre inflation pressure. Visual inspection of a tyre may cause inaccurate estimation on inflation pressure.
- If air leakage occurs while driving, do not continue to drive. Driving even a short distance can damage a tyre beyond repair.
- Be sure to install tyre valve caps properly. Otherwise, dirt could get into the valve core and cause blockage. If the caps are lost, install new ones as soon as possible.

Tyre Rotation

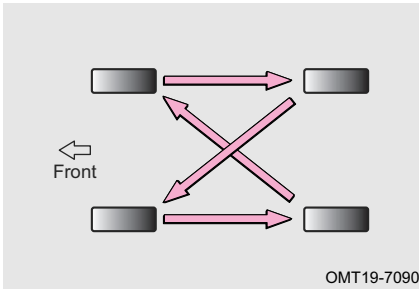

To equalize tyre wear and extend tyre service life, we recommend that you should rotate your tyres approximately every 12 months or 10,000 miles (16,093 km); the tyre rotation cycle may vary according to your driving habits and road surface conditions.

READ

Tyre rotation should be done by professionals, please contact authorized service centre.

Checking Battery

Check and make sure that the battery terminals are not corroded and that there are no loose connections, outside cracks, or loose hold-down clamps.

Your vehicle is equipped with maintenance free battery. The new battery should have the same specifications with the genuine one during replacement. We recommend that you should go to authorized service centre for battery replacement.

Checking Air Conditioning Filter

Air conditioning filter can prevent outside dust from entering vehicle through air conditioning outlets when driving for a long period of time, and it may be blocked after being used for prolonged periods of time. If operational efficiency of air conditioning decreases significantly, check filter element and replace it as necessary.

READ

- The replacement of air conditioning filter should be performed by professionals, please contact authorized service centre.
- Using air conditioning with filter removed may result in degradation of dustproof performance, affecting efficiency of air conditioning.
- A/C system for some models can achieve PM2.5 protection, please refer to your own vehicle.
- A/C system for some models can achieve N95 protection, please refer to your own vehicle.

7. MAINTENANCE

Checking Windshield Washer Fluid

If no washer fluid can be sprayed from washer nozzles, stop operating washers and check if it is necessary to add washer fluid. If it cannot operate properly after adding washer fluid, please go to authorized service centre for inspection and repair.

CAUTION

- Never add antifreeze in the windshield washer fluid, because antifreeze will damage the body painted surface.
- Do not use water as washer fluid when temperature is below zero. Otherwise, water will be frozen, causing damage to washer.
- The capacity of washer fluid reservoir is 4.5 L. When the washer fluid level is low, low washer fluid level warning light will come on and a faults message will appear on the instrument cluster (if equipped), please refer to the actual vehicle.

Checking Wiper Blades

Check the roughness of wiper blade by sliding on its edge using your finger. Wiper blade will not work effectively, if it is too rough.

CAUTION

- Do not use the wiper blades to remove frost or ice covered on the windshield.
- If there are any chips on the windscreen from gravel, please repair quickly.
- In winter, make sure that the wiper blades are not frozen to the glass before operating them to avoid damaging the wiper blades.
- Oil, silicone and fuel may cause the wiper blades to operate improperly, and it is recommended to clean the wiper blades with washer fluid.
- When the blades are lifted for maintenance, the center connector position of the blades should be properly picked up, it is required to enter maintenance mode for some models (for details, please refer to "Wiper System").

Maintaining wiper blades

- Do not use high-pressure water jet to directly wash the wiper blades while washing the vehicle, or the wiper blades could be deformed.
- In order to prevent the formation of build up that obscures view, it is recommended to clean wiper blades using glass detergent regularly once a week.
- For safety, it is advised to replace the wiper blades once or twice a year, the wiper blades can be purchased at authorized service centre.

- After washing the vehicle in the automatic car washer, apply pure water to rinse the windshield and blades, to remove the remaining wax layer.
- Do not operate wipers when windshield is dry. Doing so may scratch glass, resulting in permanent damage to wiper blades.
- Do not clean the windshield with fuel, nail polish remover, paint thinner or similar liquid, which can damage the wiper blades.
- Avoid using glass plating agent and hydrophobic agent on the front and rear windshield glass. The hydrophobic layer will fall off slowly after using, resulting in uneven friction of windshield and abnormal noise of wiper shaking.
- When the windshield surface is frosted or frozen, or when dry soil, insect, sticker or other solid particles are attached to the windshield surface, clean them with a wet cloth. Do not use a dry cloth or remove them with wiper blades directly, otherwise it will damage the glass and wiper blades.

Using wipers

- Do not swing the wiper arm manually, otherwise it may damage the wiper.
- When there is snow, leaves, branch and other objects, they should be cleaned before operating the wiper.
- Washer fluid should be added as soon as is needed, please use the windshield washer fluid as specified in this manual, and do not use tap water instead.
- In cold weather, always check if the wiper blades are frozen on the windshield before using. If they are frozen on the windshield, always unfreeze before using. Use air conditioning heating and ventilation device to warm up. Do not pour hot water directly to blades, otherwise, windshield may break or wiper blades may deform.

8-1. Label Location	Engine Performance..... 226
Vehicle Identification Number (VIN) 222	Fuel System 227
Vehicle Product Label 223	Suspension System..... 227
Engine Number..... 223	Wheel Alignment..... 228
RF Emitter and Reciever Installation (If Equipped).... 223	Wheels and Tyres 228
8-2. Vehicle Specifications	Battery..... 229
Vehicle Dimensions 224	Light Bulb Specification 229
Vehicle Type..... 225	Vehicle Components That Are Not Included in the Vehicle Size 230
Vehicle Weight..... 225	Your Rights 231
Vehicle Performance 226	Contact Us 231

8. SPECIFICATION

8-1. Label Location

Vehicle Identification Number (VIN)

Vehicle Identification Number (VIN) on actual vehicle

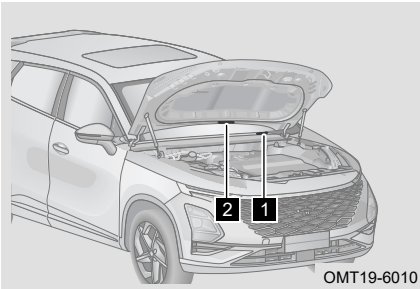

1 Vehicle Identification Number (VIN) label is located on top left of instrument panel, and can be seen from the outside through the front windshield.

2 Vehicle Identification Number (VIN) label is located on bonnet as shown in the illustration.

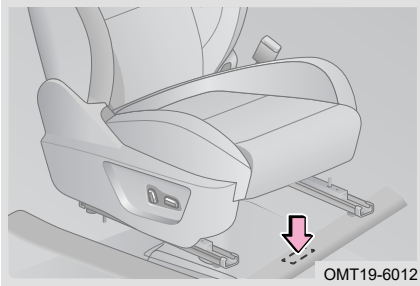

Vehicle Identification Number (VIN) is stamped under driver's seat.

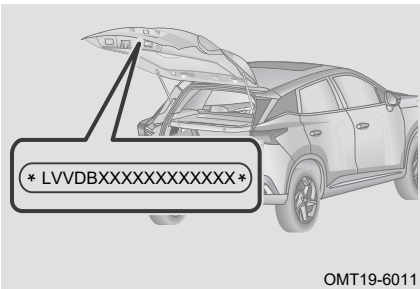

Vehicle Identification Number (VIN) label is located on boot door as shown in the illustration.

READ

- Due to regional differences, the location of VIN code shall be subject to the actual vehicle.
- If VIN needs to be read, it is recommended to read the data through the operation of authorized service centre professional serviceman.

CAUTION

It is forbidden to cover, paint, weld, cut, drill or remove Vehicle Identification Number (VIN) and areas around it.

Vehicle Product Label

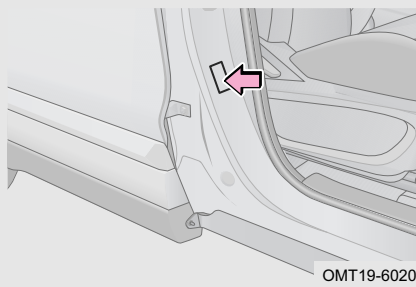

Vehicle product label is located on right quarter outer panel as shown in the illustration.

Engine Number

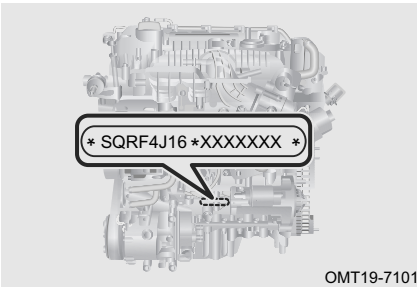

Engine number is located on engine block as shown in the illustration.

RF Emitter and Receiver Installation (If Equipped)

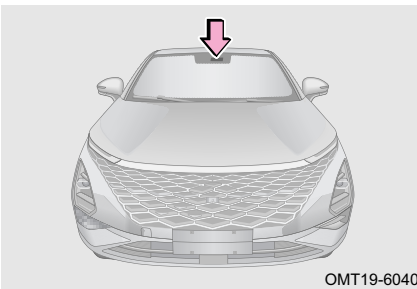

RF emitter and receiver can be placed at right side on back of front windshield for reduced interference etc.

8. SPECIFICATION

8-2. Vehicle Specifications

Vehicle Dimensions

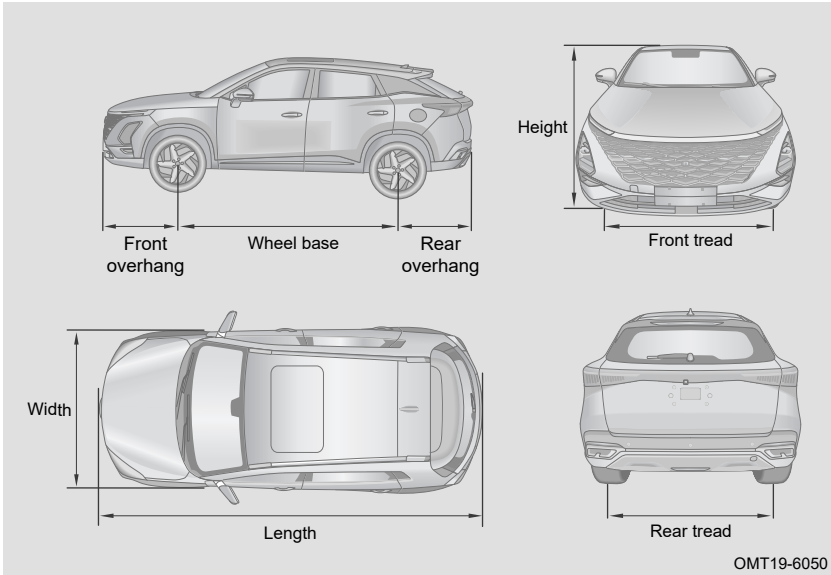

Overall Size	Length (mm)	4,400
	Width (mm)	1,830
	Height (mm)	1,588
Wheel Base (mm)		2,630
Tread	Front (mm)	1,550
	Rear (mm)	1,550
Overhang	Front (mm)	892
	Rear (mm)	878

Vehicle Type

Vehicle Type	4 × 2 front-wheel drive, front-wheel steering, transverse front-engine, two-compartment, five-door, five-seat, integral body, right-hand drive
Engine Model	SQRF4J16
Engine Type	Vertical, 4-cylinder in-line, watercooled, 4-stroke, double overhead camshaft, turbocharging, intercooler
Fuel Supply Type	Direct injection
Transmission Model	730DHB

Vehicle Weight

Vehicle Model		1.6T+2WD
Vehicle Curb Weight (kg)		1,430
Manufacturer Maximum Total Weight (kg)		1,875
Manufacturer Maximum Total Axle Weight	Front Axle (kg)	994
	Rear Axle (kg)	881
Seating Capacity (Including Driver)		5

WARNING

Please follow the vehicle load specified in the instruction manual and do not exceed the allowable total weight. Otherwise, the brake and handling performance of the vehicle may change and could cause a personal injury and accident.

8. SPECIFICATION

Vehicle Performance

Vehicle Model		1.6T+2WD
Passing Performance	Minimum Ground Clearance (mm)	139
	Minimum Turning Diameter (m)	10.9
	Approach Angle (°)	19.8
	Departure Angle (°)	22.8
Power Performance	Maximum Vehicle Speed (mph (km/h))	128 (206)
	Maximum Gradeability (%)	46.5

Engine Performance

Engine Mode	SQRF4J16
Cylinder Bore Diameter (mm)	77
Piston Stroke (mm)	85.8
Displacement (mL)	1,598
Compression Ratio	9.9:1
Maximum Net Power (kW)	136.5
Maximum Net Power Speed (r/min)	5,500
Maximum Net Torque (N·m)	275
Maximum Net Torque Speed (r/min)	2,000 - 4,000

Fuel System

Fuel Type*1	Unleaded petrol with an octane number of 91 or higher
	Unleaded petrol with an octane number of 92 or higher
	Unleaded petrol with an octane number of 95 or higher (super unleaded)
	E10, E22-E100
Fuel Tank Type	Plastic fuel tank
Fuel Tank Total Capacity	51 L
Fuel Pump	Electric fuel pump

*1: Please use the fuel recommended by authorized service centre.

READ

- Fuel tank capacity varies according to the vehicle configuration. Please refer to your own vehicle.
- Vehicles with catalytic converters can only use unleaded petrol. In order to avoid accidentally using the wrong fuel type, the fuel filler pipe has a neck-type fuel filler design, will only accommodate a standard unleaded petrol fuel nozzle.

CAUTION

- Only use recommended fuel type.
- The use of off-specification petrol may cause damage to the engine and such damage is not covered under warranty.
- Using leaded petrol will cause three-way catalytic converter to lose its effectiveness and emission control system to function improperly.
- If you accidentally fill leaded petrol to the fuel tank and start the engine (- even if only a small amount is filled), it will cause permanent damage to the catalytic converter. Therefore, if you accidentally fill leaded petrol, please go to authorized service centre for inspection and repair immediately.

Suspension System

Front Suspension	Macpherson type suspension
Rear Suspension	Multi-link suspension

8. SPECIFICATION

Wheel Alignment

Front Wheel	Front Wheel Camber	$-25' \pm 45'$
	Kingpin Caster Angle	$4^{\circ}14' \pm 60'$
	Kingpin Inclination Angle	$11^{\circ}30' \pm 60'$
	Front Wheel Toe-in	$5' \pm 5'$ (one side)
Rear Wheel	Rear Wheel Camber	$-42' \pm 30'$
	Rear Wheel Toe-in	$5' \pm 10'$ (one side)

Wheels and Tyres

Tyre Model		215/55R18; 235/50R19; T125/80D17, T125/80R17 (Non-full size spare tyre)
Rim Model		18X7J; 19X7J; 17×4T (Non-full size spare tyre)
Cold Tyre Inflation Pressure (Unladen) (kPa/bar/psi)	Front Wheel	260/2.6/38
	Rear Wheel	260/2.6/38
	Spare Tyre	420/4.2/61
Tightening Torque of Wheel bolts		130 ± 10 N·m

READ

The tyre inflation pressures listed in the table above apply only to cold tyres. The pressure increases slightly when the tyre is heated, but it is unnecessary to lower the pressure.

CAUTION

- Tyre inflation pressure should be checked at least once a month, and is particularly important if driving at high speeds.
- Cold tyre inflation pressure values are listed on a label of the driver's doorsill.

Battery

Battery Model	12V 60Ah lead-acid battery
---------------	----------------------------

Light Bulb Specification

Light Bulb Name	Nominal Light Source (Type/Model)	Replacement Advice
Headlight	LED	Replaced by authorized service centre
Front Fog Light	LED	Replaced by authorized service centre
Rear Fog Light	LED	Replaced by authorized service centre
Daytime Running Light	LED	Replaced by authorized service centre
Front Position Light	LED	Replaced by authorized service centre
Rear Position Light	LED	Replaced by authorized service centre
Brake Light	LED	Replaced by authorized service centre
High Mounted Brake Light	LED	Replaced by authorized service centre
Reverse Light	LED	Replaced by authorized service centre
Front Indicator Light	LED	Replaced by authorized service centre
Side Indicator Light	LED	Replaced by authorized service centre
Rear Indicator Light	LED	Replaced by authorized service centre
License Plate Light	LED	Replaced by authorized service centre

8. SPECIFICATION

Vehicle Components That Are Not Included in the Vehicle Size

Components not included in vehicle length size

The following devices do not have laden function and their sizes are not more than 50 mm beyond the vehicle front end or rear end, and fillet radius of edge and corner is no less than 5 mm:

- Wiper and washer
- Outer identification, including registered trademark, manufacturer name, origin, model name and type, engine emission, transmission type, driving type and other distinguishing identification of the vehicle
- Lights and light signal device
- Anti-collision rubber block and equivalent
- External sunshade device
- Customs sealing device and its protective device
- Device used to fixed raincloth and its protective device
- Locking device, hinge, handle, controller, switch
- Step plate (or ladder), vehicle climbing step plate and handle on top of bumper used for cleaning windows.
- Rear emblem plate with LOGO
- Removable trailer or towing device
- Exhaust tail pipe

Components not included in vehicle width size:

- Indirect view device

The following devices do not have laden function and their one side size exceeds the side of vehicle for no more than 50 mm, and fillet radius of edge and corner is no less than 5 mm:

- Outer identification, including registered trademark, manufacturer name, origin, model name and type, engine emission, transmission type, driving type and other distinguishing identification of the vehicle
- Lights and light signal device
- Anti-collision rubber block and equivalent
- Customs sealing device and its protective device
- Device used to fixed raincloth and its protective device
- Local water drain slot: Refers to the water drain slot used to guide rain flow above driver door (or window) and passenger door, both sides of front windshield
- Flexible protruding part of splash proof system
- Retractable step plate, lifting platform and equivalent that is in the retract state
- Locking device, hinge, handle, controller, switch

- Tyre failure signal device
- Tyre pressure indicator
- Deformed part of tyre wall directly above contact point between tyre and ground
- Reversing assistance device
- Exhaust tail pipe

Components not included in vehicle height size:

Soft part of antenna

Device without laden function:

- Intake duct
- Indirect view device
- Current collecting device of electric vehicle (including its fixing device)
- Vehicle rear air guide device is removable or folding, and its deployed and retracted length is no more than 2,000 mm and 200 mm respectively.
- Tailboard, entering/exiting slope and equivalent with a horizontal length not exceeding 300 mm in retract state
- Tail ladder

Your Rights

Depending on local law, you may have the following rights regarding your personal data: the right to object or withdraw consent, the right to access, update, and correct inaccuracies of your personal data, the right to have your personal data restricted or deleted, the right to receive your personal data and request its transfer to another organization where technically feasible, and the right to be informed of and lodge a complaint with your local data protection authority.

Contact Us

To make a query, raise a concern, or exercise your data subject rights, please feel free to contact us at privacy@mychery.com. This applies if you are based within the European Economic Area and the UK.

We take your privacy seriously and aim to respond to you within one month or within the timeline specified by the relevant local privacy protection law, after confirming your identity.

If you believe that we have not adequately addressed your complaints or concerns, you have the right to lodge a complaint with a competent data protection authority.

A

Active Speed Limit	155
Adaptive Cruise Control System (ACC)	150
Adaptive Engine Control System	126
Adjusting Steering Wheel	33
Advanced Driver Assistance System (ADAS)	188
After Starting Engine	12
Air Conditioning Cooling Operation	103
Air Conditioning Heating Operation	105
Air Outlets Airflow Control	101
Air Quality Control System (If Equipped)	103
Anti-lock Brake System (ABS) ...	185
Audio Button	91
Audio Operation	88
Audio Settings	88
Audio View	87
Authorized Service Centre is at Your Service	208
Automatic Air Conditioning	97
Automatic Emergency Braking System (AEB) / Front Collision Warning System (FCW)	166
Automatic Inside Rear View Mirror	34
Automatic Parking System (- AUTO HOLD)	133
Automatic Transmission	126
Auxiliary Fascia Armrest Box Cooling / Warming Function (If Equipped)	105

B

Battery	229
Before Starting Engine	11
Blind Spot Detection (BSD) System	163
Boot Door Emergency Opening .	118
Brake	136

C

Check the Exhaust System	14
Checking Air Conditioning Filter .	217
Checking Battery	217
Checking Brake Fluid Level	212
Checking Coolant Level	213
Checking Drive Belt	214
Checking Fuse	204
Checking Oil Level	211
Checking Radiator and Condenser	214
Checking Transmission Fluid Level	212
Checking Tyres	215
Checking Windshield Washer Fluid	218
Checking Wiper Blades	218
Child Presence Detection in Rear Seat (If Equipped)	65
Contact Us	231
Cybersecurity Notice for Scrapping or Resale	20
Cybersecurity Support Service Update or Termination Notice	20

D

Data Privacy	187
Delivery Inspection Certificate	8
Door Mechanical Switch	78
Doors Lock Switch	77
Drive Away Information System .	172
Driver Drowsiness and Attention Warning (DDAW)	187
Driving on Road Covered with Ice and Snow	18

E

Effective Range	72
Electric Air Conditioning	96
Electric Parking Brake System (EPB)	131
Electric Power Steering System (EPS)	129
Electronic Stability Program System (ESP)	184

ALPHABETICAL INDEX

Emergency Lane Keeping (ELK) System	162
Emergency Towing	202
Enabling and Disabling Front Passenger Airbag	64
Engine Number	223
Engine Performance	226
ENGINE START STOP Switch...	122
Extended Function	187
Exterior Lighting	39

F

"Face to face" Consultative Service Card	3
Fogging Instructions for Light.....	44
Follow Me Home Function.....	43
Front Seats	46
Fuel System.....	227
Fuel Tank Cover	118
Fuse Box	203

H

Hazard Light	190
Head Restraints.....	45
Heated Steering Wheel (If Equipped)	32
Hill Descent Control System (HDC) (If Equipped).....	157
Horn	32
How to Read This Manual	2
How to Save Fuel and Extend Life of Vehicle	10

I

If Battery is Flat	198
If Engine Coolant Temperature is High	197
If You Have a Flat Tyre While Driving.....	192
If Your Vehicle Cannot Start Normally	200
Immobilizer System.....	75
Index	2
Information display area (dual display).....	24

Installing Child Restraint Systems	60
Installing Towing Eyelet	202
Instrument cluster view	22
Intelligent Avoidance System.....	171
Intelligent Headlight Function (IHC)	44
Interior Active Ventilation and Automatic Cleaning (If Equipped)	102
Interior Lighting	42

K

Key Information	69
Keyless Entry	73

L

Lane Departure Prevention System (LDP)	160
Lane Departure Warning System (LDW)	158
Light Bulb Specification	229

M

Manual Boot Door.....	114
Mode Adjustment.....	101
Moon Roof Jam Protection Function (If Equipped).....	86
Moon Roof Remote Control Function (If Equipped).....	85
Multi-Collision Brake System (MCB)	183

N

Never Drive Through Flooded Water	16
New Vehicle Break-in	9
New Vehicle Inspection.....	8
Normal Maintenance	210
Normal Starting and Turning off .	123

O

Off-road Driving	15
Opening/closing the bonnet.....	113
Operation/Malfunction Indicator ...	27
Outside Rear View Mirror	34

P

Panoramic View Monitor System (If Equipped)	177
Parking on Slope	13
Parking Operations	12
Parking Radar System.....	181
Parking View Monitor System (If Equipped).....	176
Phone-link	92
Pictorial Index	2
Power Boot Door	115
Power Moon Roof (If Equipped) ...	84
Power Outlet	110
Power Windows.....	80

R

Rear Cross Traffic Alert (- RCTA) System.....	164
Rear Cross Traffic Braking (- RCTB) System (If Equipped)....	164
Rear Door Child-Protection Lock..	79
Recommended Child Restraint Systems	57
Reflective Strip	191
Remote Start.....	76
Repair and Maintenance	208
Replacing Fuse	205
Replacing Key Battery	70
RF Emitter and Reciever Installation (If Equipped).....	223

S

Safety Check	11, 209
Safety Instructions for Using Child Restraint System.....	55
Seat Belt Pretensioner.....	54
Seat Belts	49

Seat Heating Function (If Equipped)	49
Second Row Seat	48
Setting	25
Smart Vehicle Locating Function ..	43
Spare Tools (If equipped).....	191
Speed Limit Assist System (SLA) (If Equipped).....	149
SRS Airbags	137
Starting and Turning off in Emergency.....	124
Storage Space	108
Sun Visors , Vanity Mirrors and TicketClips	112
Suspension System	227
Symbols in the Manual	7

T

Table of Contents.....	2
Top Tether	58
Towing Vehicle	200
Traffic Jam Assist System (TJA) / Integrated Cruise Assist System (ICA).....	169
Tyre Chains	18
Tyre Pressure Monitoring System (TPMS)	172
Tyre Rotation	217

U

Unlocking Doors with Inside Handle.....	77
USB Port	111

V

Vacuum Booster	135
Vehicle Arming	74
Vehicle Components That Are Not Included in the Vehicle Size	230
Vehicle Dimensions.....	224
Vehicle Identification Number (VIN)	222
Vehicle Performance	226
Vehicle Product Label.....	223

ALPHABETICAL INDEX

Vehicle Type	225
Vehicle Weight	225
Voice Recognition Function	91

W

Warning Triangle	191
Wheel Alignment	228
Wheels and Tyres	228
When Driving	12
When Driving on Slippery Road Surfaces.....	16

Window Jam Protection Function .	82
Window Remote Control Function	81
Winter Driving Tips.....	17
Wiper Blade Replacement.....	37
Wiper Operation	35
Wireless Charging	105

Y

Your Rights	231
-------------------	-----